

Instructions for using

SINGER

Automatic

SWING-NEEDLE MACHINE

MODEL 319 K

THE SINGER MANUFACTURING COMPANY



SINGER* 319K

Automatic SWING-NEEDLE MACHINE

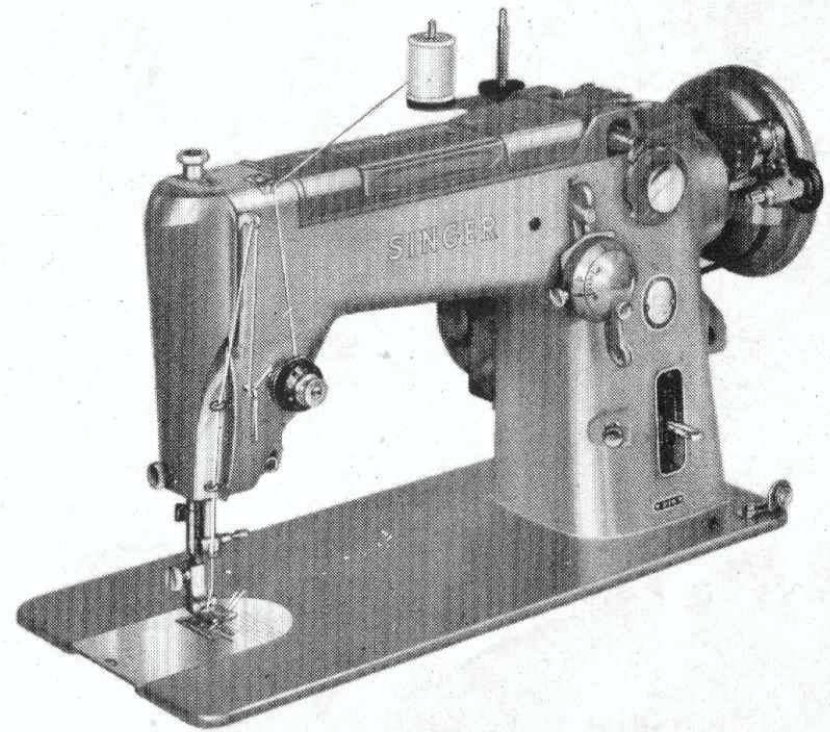

Outstanding for its simplicity, the 319K2 is a straight stitching machine of highest quality plus an automatic zigzag machine with the convenience of built-in stitch designs affording unlimited versatility.

Form K6208
(157)

*A Trade Mark of THE SINGER MANUFACTURING COMPANY

AS THE OWNER OF THIS NEW SINGER "AUTOMATIC"

You should take pride in having the finest zigzag sewing machine ever made for home use. You can be confident that this extraordinarily versatile machine is built with the expert care and knowledge that have made SINGER the best-known and respected name in sewing machines the world over for more than a century. With it you can do beautiful and ornamental stitches **automatically!** No more skill is required than it takes to sew an ordinary seam. This amazing machine will **speed** through your straight sewing and then, by simply raising one or more levers you can do decorative stitching in no more time or with no more effort than it takes to do straight stitching.

The 319K2 has all of the convenience of built-in stitches, yet all of the versatility of interchangeable FASHION* Discs. Change the FASHION Disc on the front of the machine and you have added not one but many new stitches. Designs result from single lever operation or from the use of a combination of levers. Truly the 319K2 is the simplest, most versatile automatic zigzag machine on the market today.

TO GET THE MOST ENJOYMENT FROM YOUR SINGER

Take advantage of the free sewing lessons to which you are entitled! Skilled, SINGER-trained teachers will give you personal guidance and assist you in learning the fundamentals of home sewing.

Copyright © 1956 by The Singer Manufacturing Company

SINGER SERVICE

Wherever you go you will find expert, dependable **SINGER*** Service close at hand. **SINGER** is interested in helping you keep your **SINGER** Sewing Machine in top running condition. That is why you should always call your **SINGER SEWING CENTRE** if your machine ever requires adjustment or repair. When you call your **SINGER SEWING CENTRE** you can be sure of obtaining the service of a trained **SINGER** repair man and can be assured of warranted **SINGER*** parts when needed! Look for the famous red "S" Trade Mark on your **SINGER SEWING CENTRE** and the ever ready **SINGER** Service Car.

EVERYTHING FOR THE WOMAN WHO SEWS

The answer to your sewing needs is at your **SINGER SEWING CENTRE**. There you will find a wide choice of sewing necessities and notions, sewing instructions and guidance and services for covering buttons, hemstitching, making belts and buckles, to mention a few. Look in your telephone directory under **SINGER SEWING MACHINE COMPANY**.

ADVANCED FEATURES OF THE SINGER 319K

1. **SIMPLICITY**—Truly the easiest to operate zigzag machine made.
2. **VERSATILITY**—A straight stitching machine of highest calibre capable of full zigzag and automatic decorative stitching.
3. **AUTOMATIC STITCHES**—By means of levers—scallops, blind stitched hems, decorative designs, simple mending are automatically accomplished. An amazing number of lovely designs result from using a combination of levers. For a greater variety of stitch designs—more than you've ever thought possible—merely change the **FASHION Disc**.
4. **TWIN-NEEDLE STITCHING** can be done by inserting the **SINGER Twin-Needle**, especially sturdy and accurate because the two blades are bonded in metal.
5. **ROTARY MOVEMENT** for smooth, quiet performance . . . full rotary sewing hook.
6. **FULL VISION BOBBIN CASE** facilitates removal and replacement. Time-saving, extra capacity, round bobbin.
7. **CALIBRATED TENSION** within a single turn, tensions are regulated for any type of fabric and for any type of stitching.
8. **REVERSIBLE FEED** for sewing either forward or backward—easy to back stitch and fasten ends of seams.
9. **CALIBRATED STITCH REGULATOR** with fingertip control.
10. **SMOOTH, SEAMLESS THROAT PLATES** clip on to ensure snag-free performance.
11. **POSITIVE FEED** for handling all types of fabrics.
12. **FEED THROW-OUT** permits darning and embroidering.
13. **PERFECT CONTROL** whether sewing at high or low speeds, the pick up and stop are quick and effortless.
14. **SINGER* Light** illuminates working area—prevents eye strain, lamp easily renewed.
15. **ONE-WAY NEEDLE CLAMP** makes it almost impossible to place needle in clamp incorrectly.
16. **ALUMINIUM CONSTRUCTION** means durability and light weight.

ELECTRICAL INFORMATION

The SINGER Electric Motor*

is located at the back of the machine, and can be supplied for operation on alternating or direct current. Orders must state the catalogue number of the motor, or the voltage, and in the case of alternating current, the number of cycles.

Before Inserting Electric Plug—

be sure that voltage and number of cycles stamped on motor nameplate are within range marked on electric meter installed by electric power company.

Electrical Connections for Machine

Push 3-pin safety plug **A**, **Fig. 1**, into 3-pin terminal block at right of machine and connect plug at other end of cord to electric outlet.

Speed Controller

The speed of machine is regulated by amount of pressure on foot controller or knee controller.

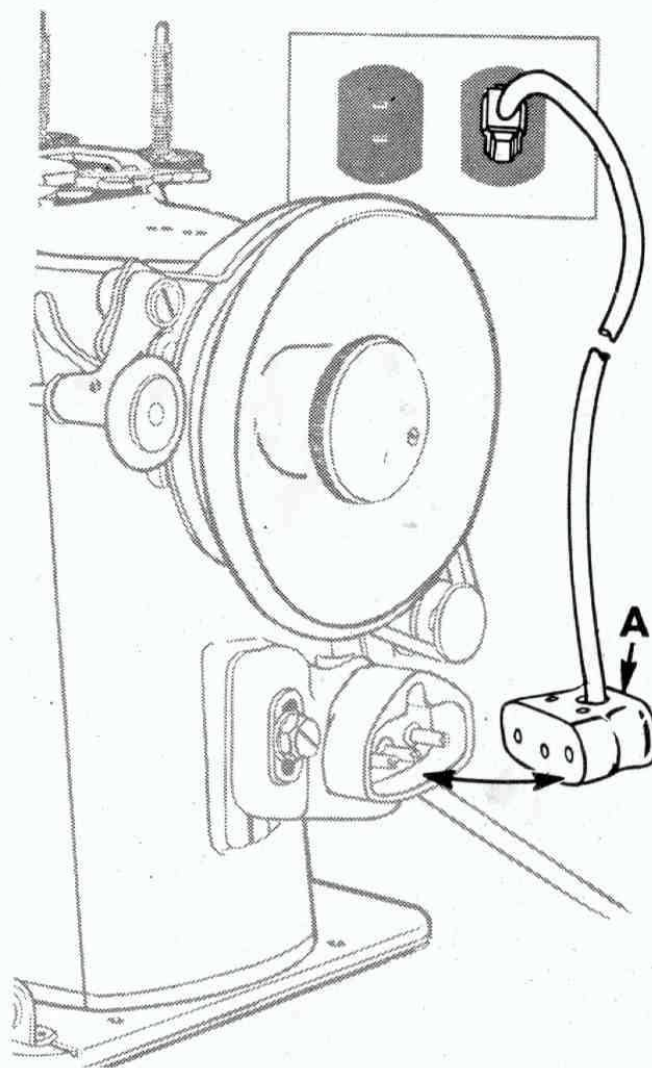

Fig. 1. Electrical Connection for Machine

AUTOMATIC STITCHING

When all stitch levers, shown in **Fig. 2**, are at their lowest position and the bight control lever **T**, **Fig. 22**, in "0" position, highest quality straight stitching is done.

An amazing number of lovely useful stitches are produced automatically when you raise one or more of the stitch levers.

For the most attractive of these combination designs not more than three levers should be used.

Twenty-five additional FASHION Discs are furnished with the machine. Each of these FASHION Discs is interchangeable with the one on the front of the machine. With each disc, a new variety of combinations can be produced, through the use of one or more levers.

Attached to the outside of the machine is the Blind Stitch disc, which is engaged by the first lever.

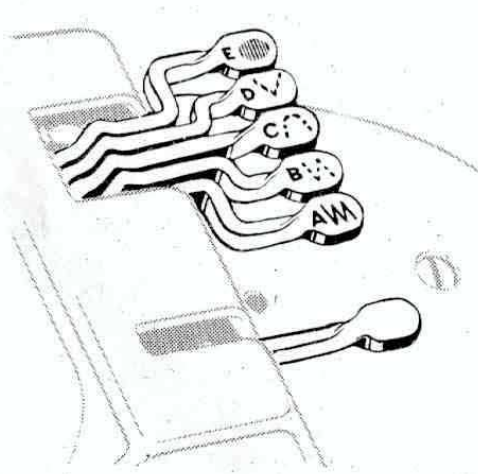

Fig. 2. Stitch Levers on 319K Machine

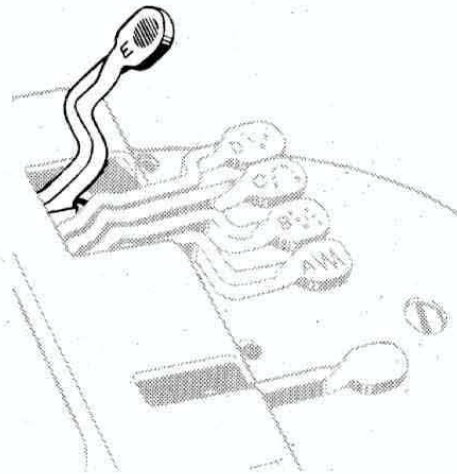

Fig. 3. Stitch Lever E in "Up" Position

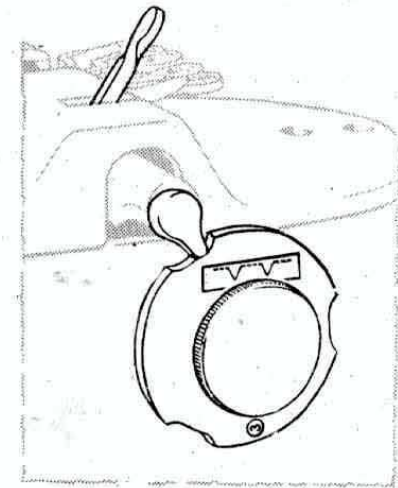

Fig. 4. Blind Stitch Disc No. 3 on 319K Machine

AUTOMATIC STITCHING

Five automatic stitch designs are built into the machine. Merely lift the designated lever to produce the stitch indicated on the lever. The maximum width of the stitch is achieved when bight is set at 5. Narrower designs result from setting the bight at less than 5. An almost zero stitch length gives a solid design, while a longer stitch length gives an open pattern. Twin needle stitching is done at 3 bight or less.

Zigzag—Lever A 

For: Buttonholes
Sewing buttons
Reinforcing seams
Hairline seams
Cording seams
Invisible seams on lace

Applique
Satin stitch
Script stitch
Shadow applique
Satin stitch scallop

Multiple Stitch Zigzag—Lever B 

For: Reinforcing
Patching
Mending
Decorative stitching

Overlapped seams
Abutted seams
Elastic seams
Binding blankets

Scallop—Lever C 

For: Faced scallops
Decorative stitching

Zigzag Point—Lever D 

For: Decorative edging
Decorative border

Applique of bands
or lace
Decorative applique

Ball—Lever E 

For: Motif designs
Border designs
Decorative applications
Monograms

Blind Stitch—Disc 3 

For: Hems
Facings
Zippers
Overedging seams and facings
Decorative stitching
Applying bands and lace

NOTE: To change the direction of pattern produced by FASHION Discs 5, 10, 15, 16, 17 and 18, reverse the disc on the shaft.

AUTOMATIC STITCHING

Twenty-five additional FASHION Discs are included with this machine. (Discs 14 and 19 are built into the machine as Levers D and E, respectively, and produce designs as shown on page 7.) The 25 additional discs produce the following designs:

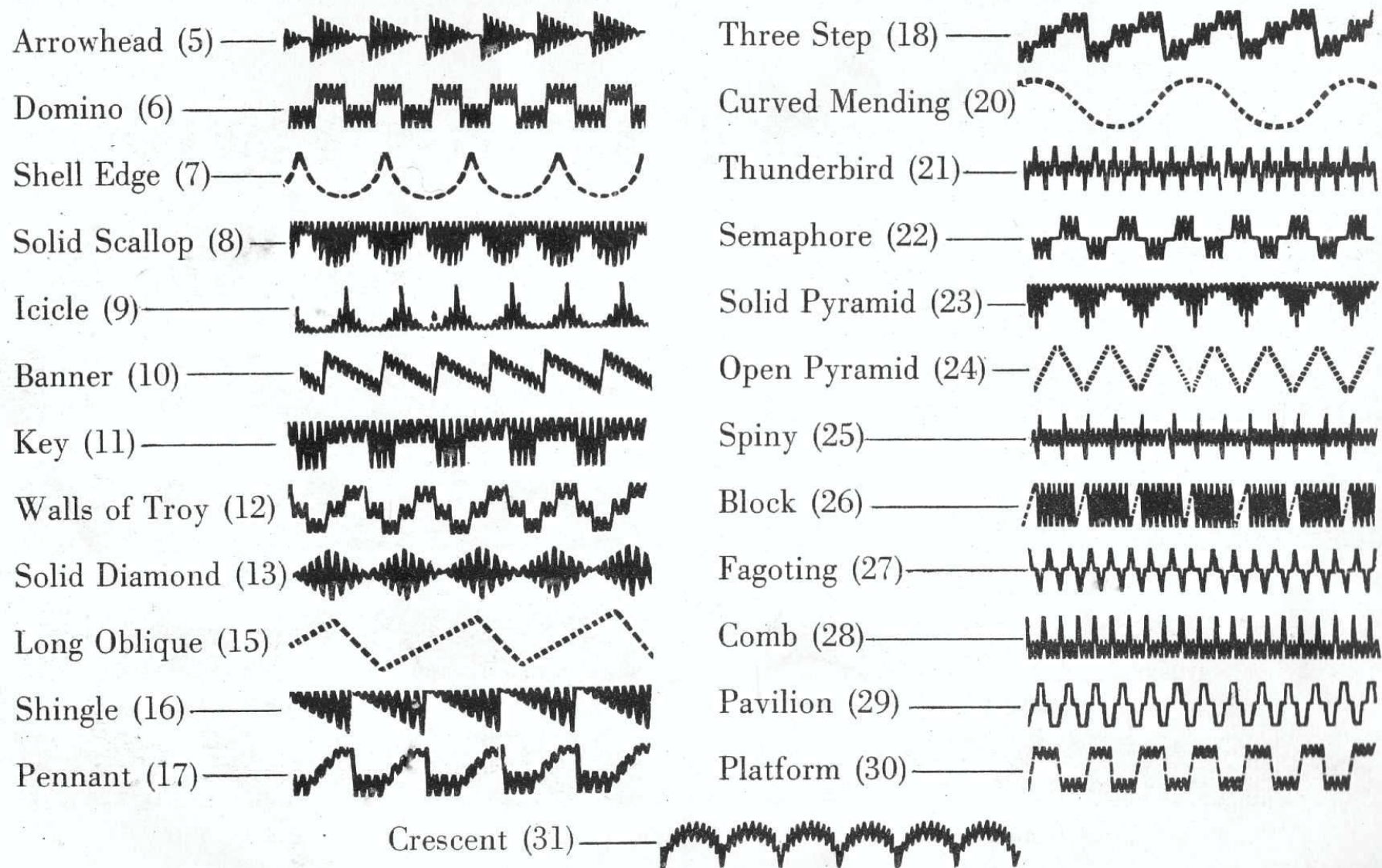

COMBINATION STITCHES (With Levers)

The following stitches result from using at one time **two or more** of the levers which engage the built-in FASHION Discs:



Levers A and B



Levers A and C

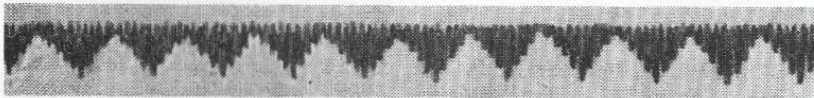

Levers A and D



Levers A and E

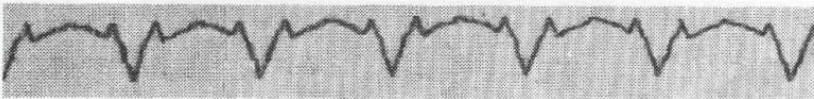

Levers B and C

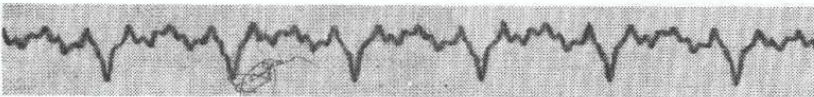

Levers B and D

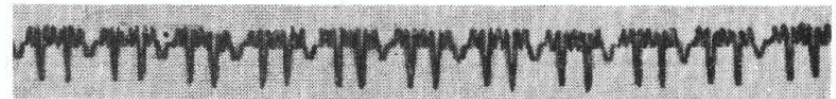

Levers B and E



Levers C and E

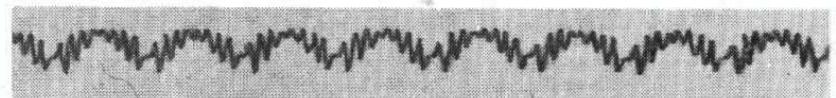

Levers D and E



Levers A, C and E

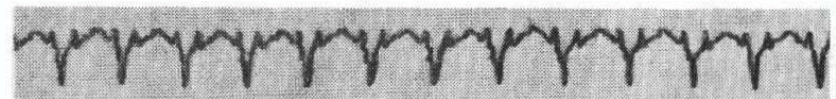

Levers B, C and D

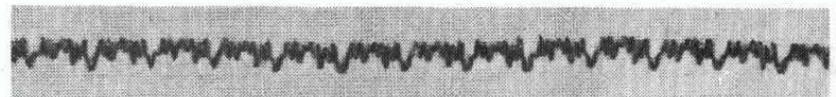

Levers B, D and E

COMBINATION STITCHES (With Levers and Disc)

The following stitches are produced by using at the same time **one or more** of the levers which engage the built-in FASHION Discs and Discs 5 or 6:



Lever A, Disc 5



Lever B, Disc 5



Lever E, Disc 5

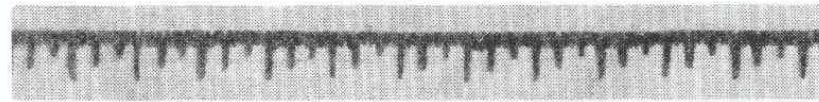

Levers A and B, Disc 5



Levers A and E, Disc 5

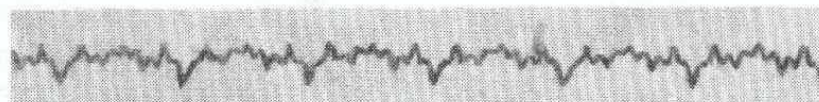

Levers B and D, Disc 5

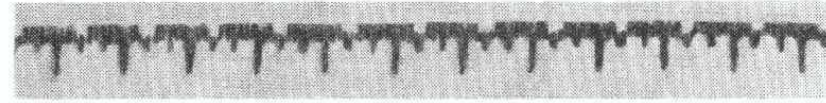

Levers B and E, Disc 5

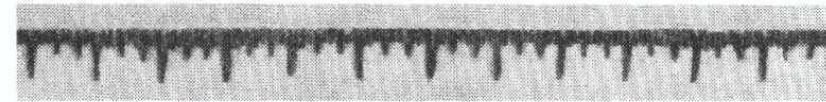

Levers A, B and E, Disc 5



Lever A, Disc 6



Lever B, Disc 6



Lever D, Disc 6



Levers A and E, Disc 6

COMBINATION STITCHES (With Levers and Disc)

The following stitches are produced by using at the same time **one or more** of the levers which engage the built-in FASHION Discs and Discs 7, 8, 9 or 10:

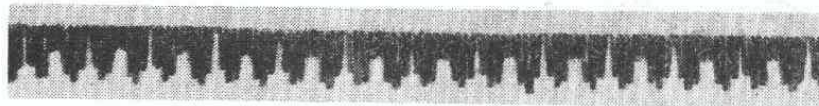

Lever A, Disc 7



Lever B, Disc 7

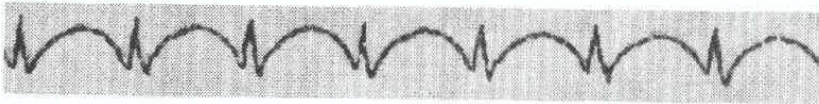

Lever C, Disc 7

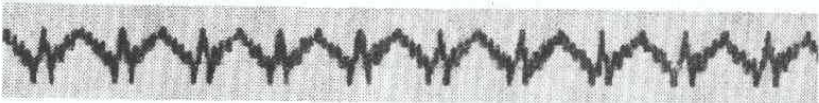

Lever D, Disc 7



Lever E, Disc 7



Levers A and B, Disc 7



Levers A and D, Disc 7

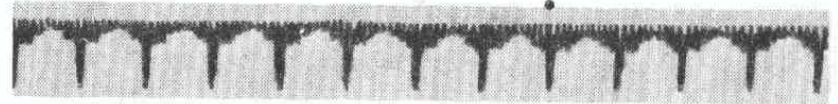

Levers B and C, Disc 8



Levers B and D, Disc 8



Levers B and D, Disc 9

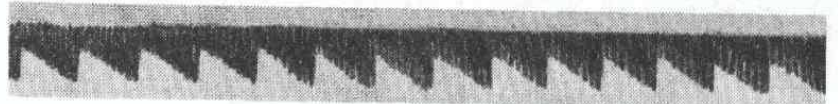

Lever A, Disc 10



Levers D and E, Disc 10

COMBINATION STITCHES (With Levers and Disc)

The following stitches are produced by using at the same time **one or more** of the levers which engage the built-in FASHION Discs and one of the discs numbered from 11 to 21:

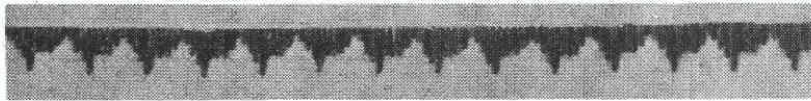

Lever D, Disc 11

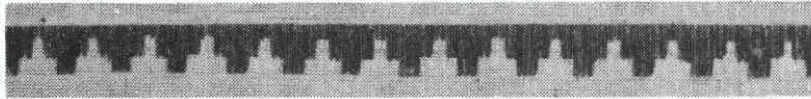

Lever A, Disc 12

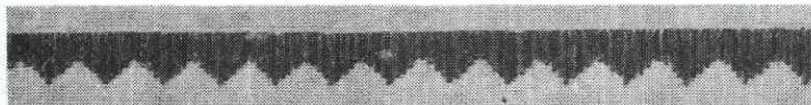

Lever A, Disc 13



Lever E, Disc 15



Lever E, Disc 16



Lever A, Disc 17



Levers A and E, Disc 18



Lever A, Disc 20

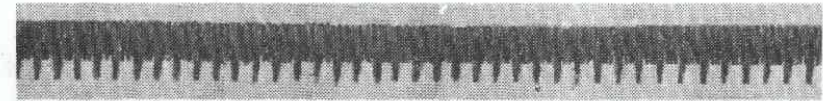

Lever A, Disc 21

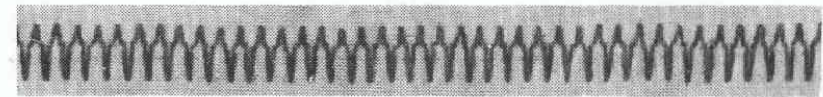

Lever B, Disc 21

COMBINATION STITCHES (With Levers and Disc)

The following stitches are produced by using at the same time **one or more** of the levers which engage the built-in FASHION Discs and one of the discs numbered from 21 to 30:



Lever D, Disc 21



Lever D, Disc 26



Lever E, Disc 21



Lever A, Disc 29



Lever E, Disc 22



Lever A, Disc 30

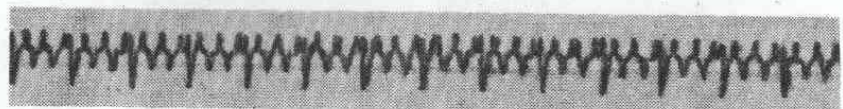

Lever B, Disc 25



Lever B, Disc 30



Lever A, Disc 26



Lever D, Disc 30

TWIN NEEDLE DECORATIVE STITCHING

The following stitches are produced by using one lever at a time or one of the FASHION Discs as listed. The bight is **limited to 3** and the stitch length is set between 25 and 0. The satin stitch foot is used for closed designs. Scalloping and running stitches are done with the all-purpose presser foot:

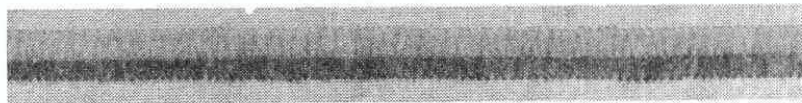

Lever A

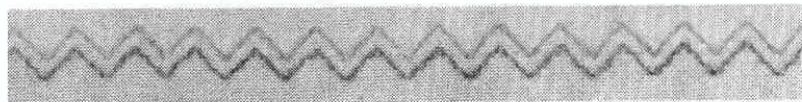

Lever B



Lever C



Lever D

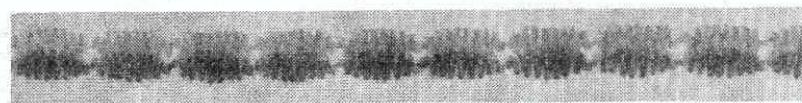

Lever E



Disc 3



Disc 5



Disc 6

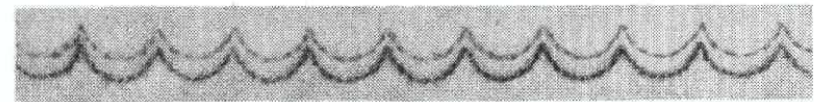

Disc 7



Disc 8

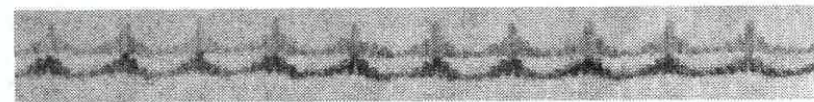

Disc 9

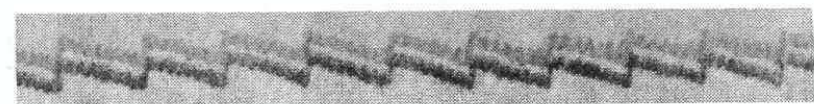

Disc 10

TWIN NEEDLE DECORATIVE STITCHING

The following stitches are produced by using **one or more** levers and one FASHION Disc at the same time as listed. The bight is **limited to 3** and the stitch length is set between 25 and 0. The satin stitch foot is used for closed designs and the scalloping and running stitches are done with the all-purpose presser foot.

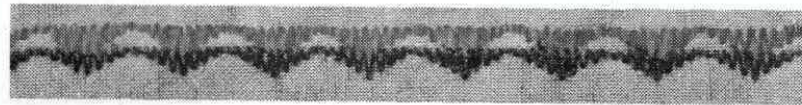

Levers A and D

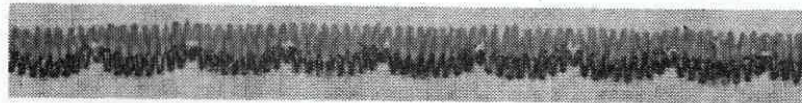

Levers A and E

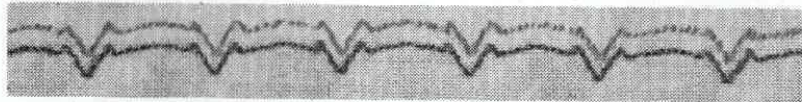

Levers B and C

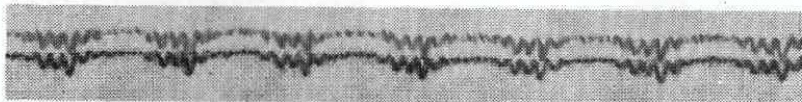

Levers A, C and E



Lever E, Disc 5



Levers A and B, Disc 5

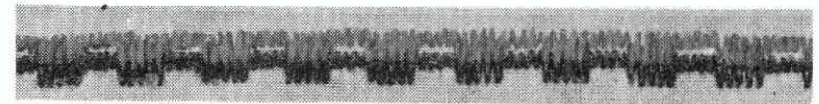

Lever A, Disc 6

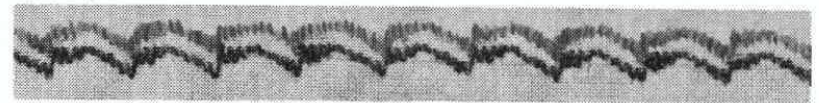

Lever D, Disc 6

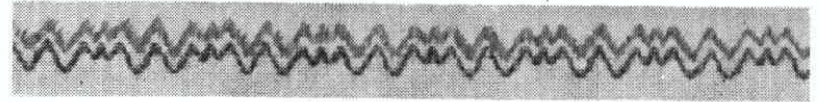

Lever B, Disc 7

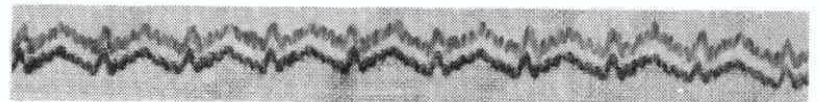

Lever D, Disc 7

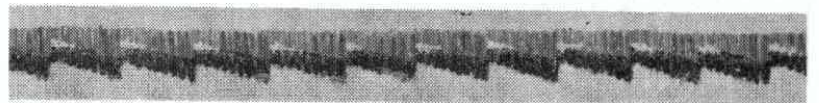

Lever A, Disc 10

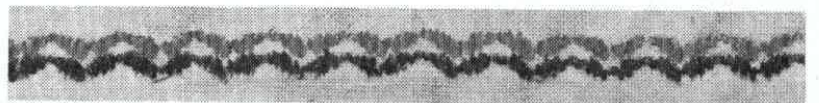

Levers D and E, Disc 10

FABRIC, THREAD, NEEDLE AND STITCH LENGTH CHART

| TYPES OF FABRICS | THREAD SIZES | NEEDLE SIZES | MACHINE STITCH SETTINGS FOR STRAIGHT SEWING | |
|---|--|----------------|---|---------------|
| | | | INSIDE SEAMS | TOP STITCHING |
| Filmy materials comparable to Net, Marquisette, Chiffon, Silk and Chiffon Velvets, Voiles, Ninon | 50 Embroidery 100 Cotton 50 Silk Nylon Thread | 9 | 15 to 20 | 15 to 20 |
| Sheer materials comparable to Lawn, Dimity, Synthetic Sheers, Paper Taffetas, Pure Silks, Gossamer Silks, Silk or Synthetic Tricots, Synthetic Velvets, Satins | 50 Embroidery 80 to 100 Cotton 50 Silk Nylon Thread | 11 | 12 to 15 | 15 to 20 |
| Lightweight materials comparable to Gingham, Chambray, Pique, Poplin, Percalé, Cretonne, Chintz, Faille, Bengaline, Wool Flannel, Wool Jersey, Wool Crepe, Cotton Velvets and Velveteens, Lightweight Suitings | 50 Mercerized 60 to 80 Cotton 50 Silk | 14 or 16 | 12 | 15 to 18 |
| Medium heavy materials comparable to Corduroy, Crash, Gabardine, Rep, Heavy Suitings and Coatings | Heavy Duty Mer. 40 to 60 Cotton Nylon Thread | 16 | 10 | 12 |
| Heavy materials comparable to Sailcloth, Denim, Ticking, Overcoatings | 30 to 40 Cotton Thread | 18 | 8 | 10 |
| Plastic materials | 50 Embroidery Nylon Thread 50 Mercerized | 11 or 14 | 10 | 12 |

When ordering needles, always specify "Class and Variety 206 x 13" and state the size and quantity required.
See page 43 for ordering TWIN NEEDLES.

NEEDLES AND THREAD

This machine uses a 206x13 Needle—available in Sizes 9, 11, 14, 16 and 18.

For perfect stitching, thread should be selected according to fabric to be stitched. Needle must be of correct size for thread to pass freely through eye of needle. Select correct needle according to table on **page 16**. Be sure that needle is not blunt or bent.

NOTE: Thread breakage is sometimes caused by variations in the diameter of thread. Such breakage is overcome by using the next size larger needle.

Use like threads for needle and bobbin. Do not use silk on bobbin and mercerized thread in needle, or vice versa.

TO SET THE NEEDLE

Raise the needle bar to its highest position and loosen needle clamp thumb screw **B**, **Fig. 5**. Insert needle into clamp as far as it will go with **flat side to the back** and **long groove toward you**. Then tighten thumb screw **B**.

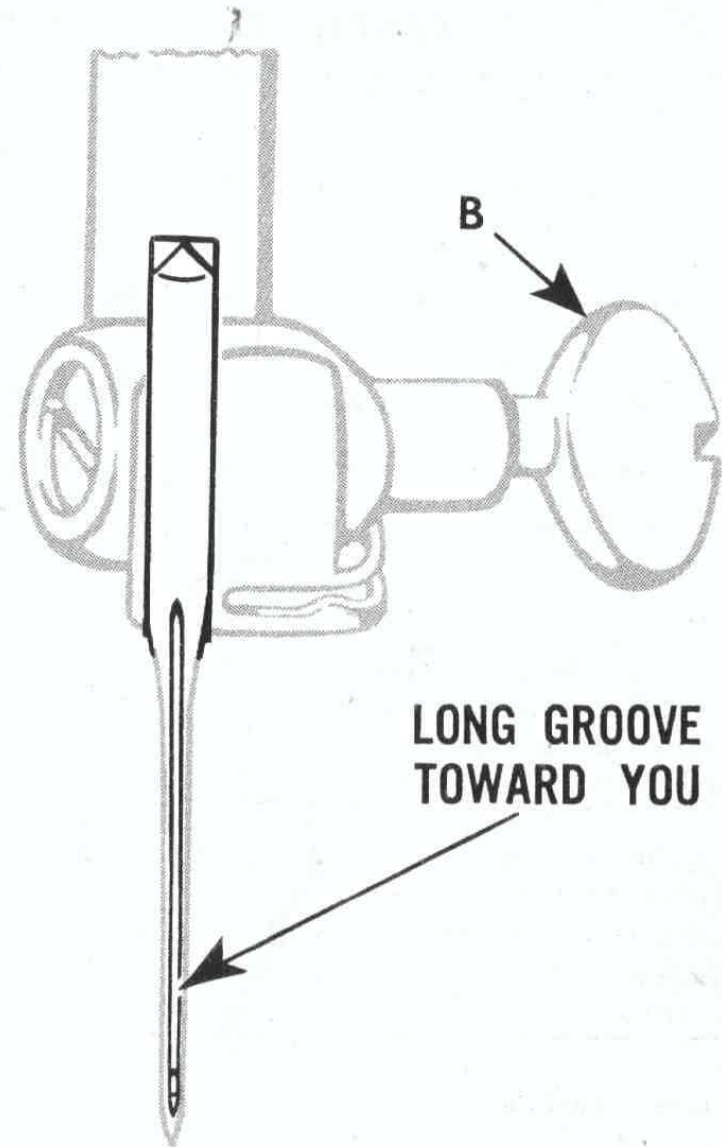

*Fig. 5. Set Needle, Flat to Back,
Long Groove Toward You*

UPPER THREADING—SINGLE NEEDLE

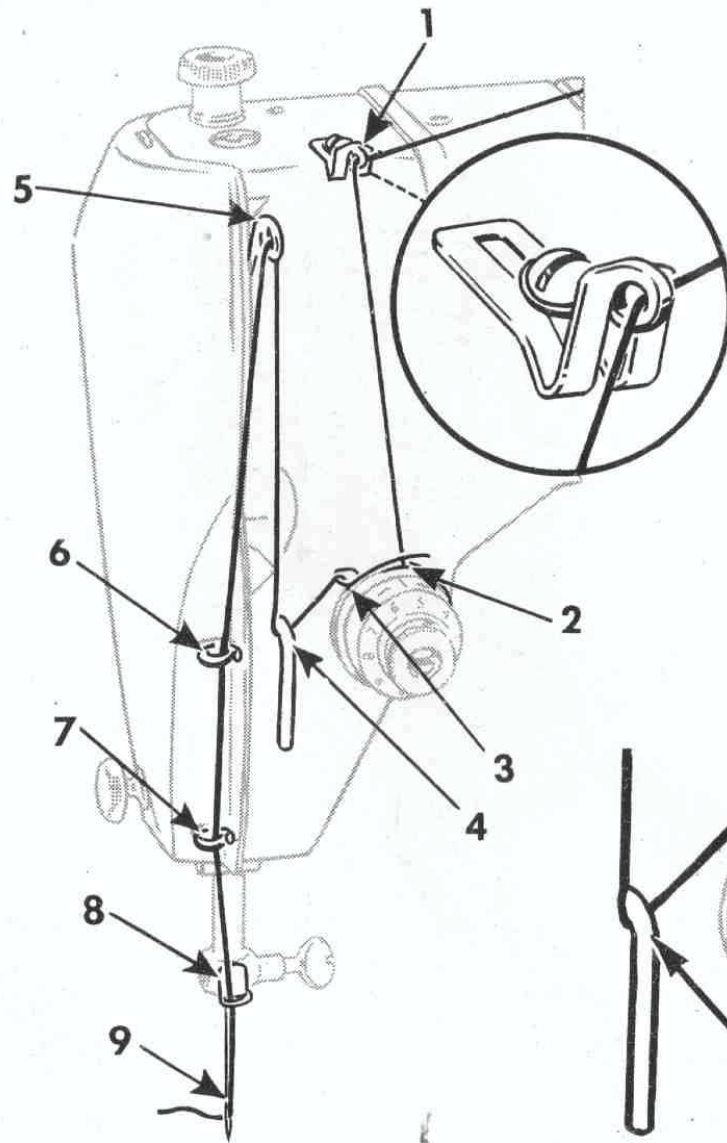

Fig. 6. Upper Threading

Raise take-up lever 5 to its highest point.
Place thread on spool pin and hold with right hand.
Lead thread into self-threading guide 1 from under side,
Down and from right to left behind or in front of centre tension disc 2 (Centre disc separates threads for twin needle sewing.)
Into the loop of the take-up spring 3,
Under the slack thread regulator 4,
Up and from right to left through hole in take-up lever 5,
Down through guides 6 and 7 on face plate,
Into guide 8 on needle clamp,
From **front to back** through eye of needle 9.
Draw about two inches of thread through eye of needle with which to start sewing.

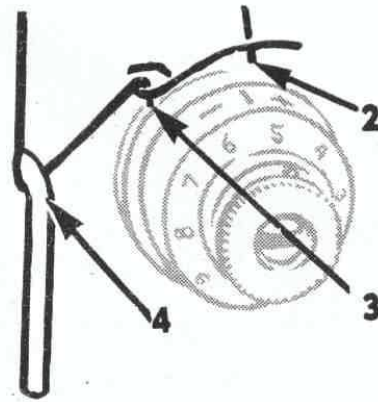

Fig. 7. Threading Tension

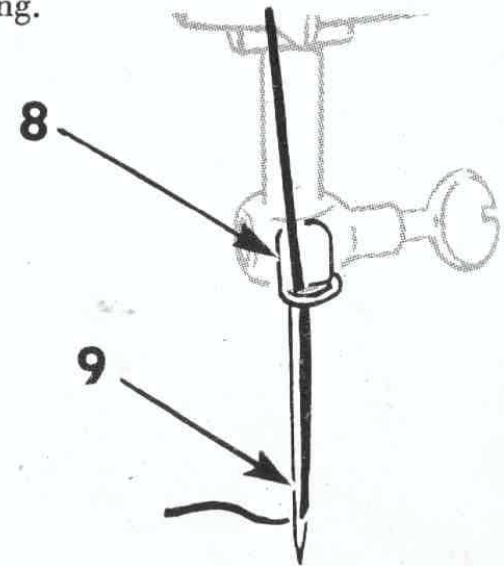

Fig. 8. Threading Needle from Front to Back

TO REMOVE THE BOBBIN

1. Bring take-up lever to its lowest point.

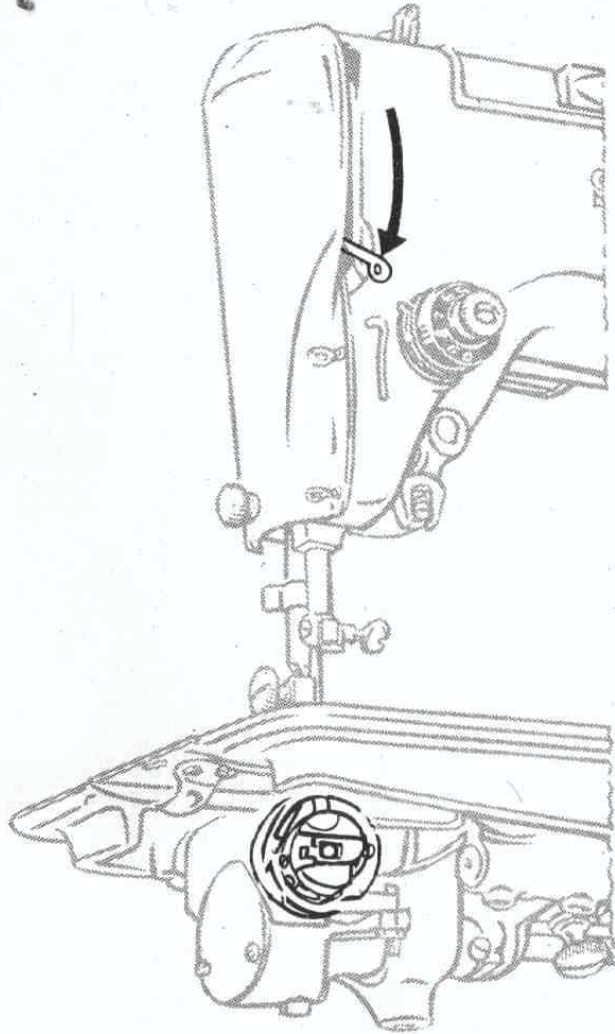

Fig. 9

2. Tilt machine back on its hinges.

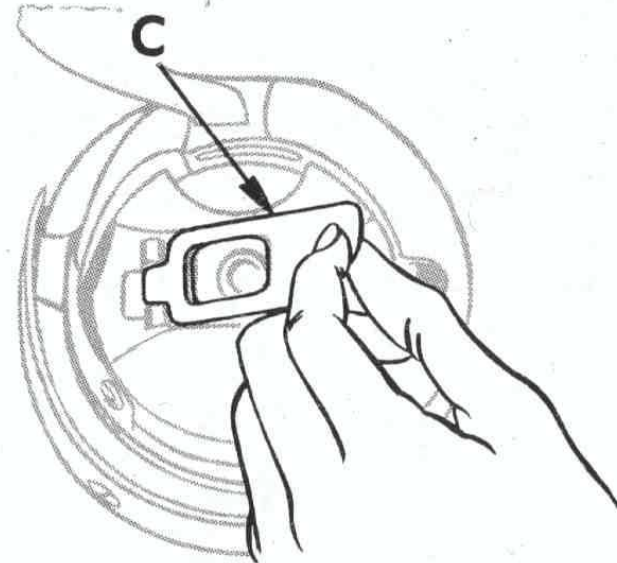

Fig. 10

3. Open bobbin case latch C.

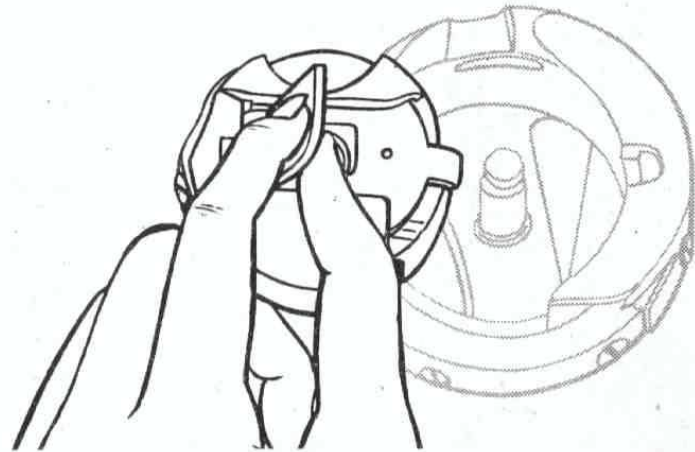

Fig. 11

4. Lift case and release latch to remove bobbin.

TO WIND THE BOBBIN

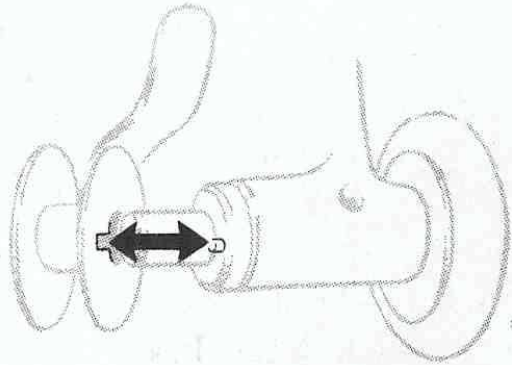

Fig. 12

1. Place bobbin on bobbin winder spindle and turn until pin enters slot in right side of bobbin.

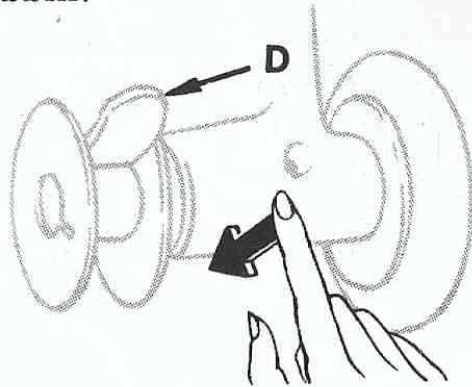

Fig. 13

2. Lock bobbin in place by pressing bobbin winder downward until latch **D** engages.

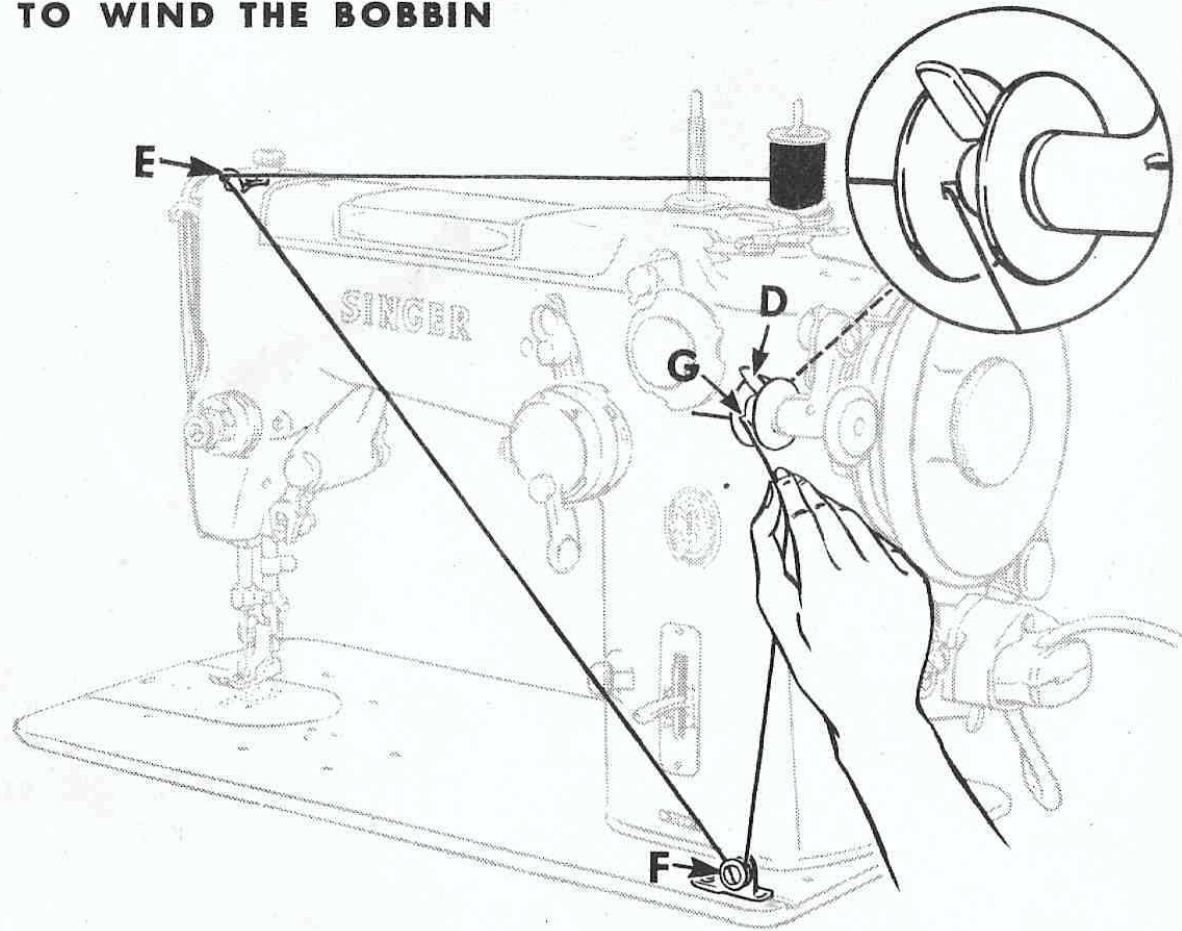

Fig. 14

3. Place spool of thread on either spool pin.

Draw thread through self-threading guide **E** on arm of machine and pass thread down and from left to right under tension **F** on bed. Lead thread up to bobbin and thread from inside, through slot in left side of bobbin **G**.

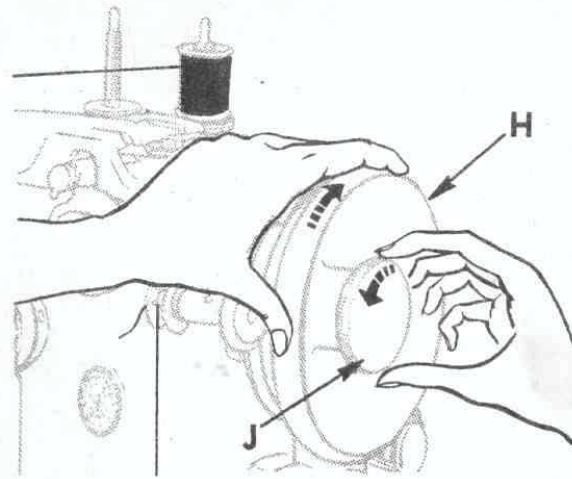

Fig. 15

4. Hold hand wheel **H** with left hand, and with right hand, loosen stop motion screw **J** to release hand wheel from stitching mechanism as shown above.

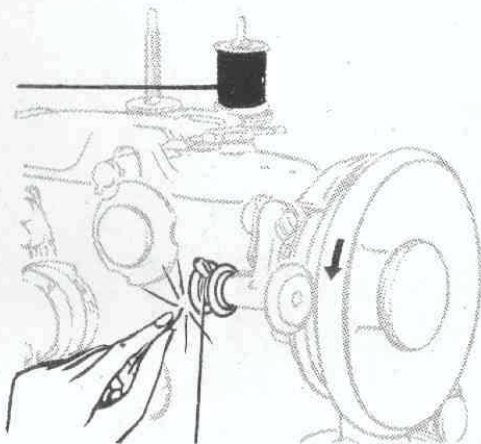

Fig. 16

5. Hold end of thread and press controller pedal as for sewing. End of thread must be held until it breaks off.

Allow tension discs **F**, Fig. 14, to control flow of thread so that it winds on bobbin in uniform, level rows. Do not guide or hold thread when winding bobbin.

The bobbin winder will stop automatically when the bobbin is filled. When less than a full bobbin is desired, lift latch **D**. Remove bobbin from spindle and retighten screw **J**, Fig. 15.

NOTE: If bobbin does not wind evenly, loosen screw which holds tension bracket **F** in position and move bracket to the left if bobbin winds high on the right; move bracket to the right if bobbin winds high on the left. When bracket is properly centered, thread will wind evenly across bobbin. Retighten tension bracket screw.

Bobbin can be wound while machine is sewing.

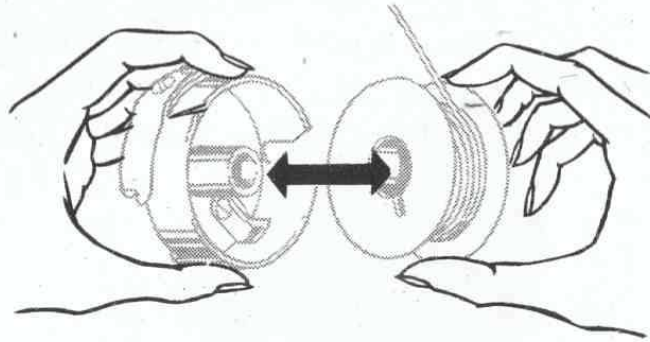
TO THREAD BOBBIN CASE*Fig. 17*

1. Hold bobbin so that thread will unwind in direction shown.

Hold bobbin case as shown above and place bobbin into it.

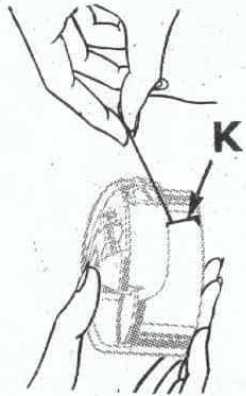
*Fig. 18*

2. Pull thread into slot **K**, under tension spring **L** and into slot **M** at end of spring. Allow about three inches of thread to hang free from bobbin case.

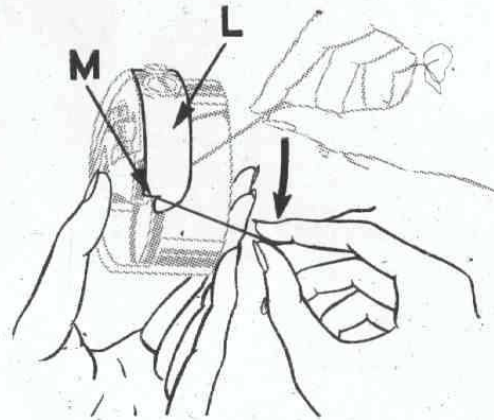
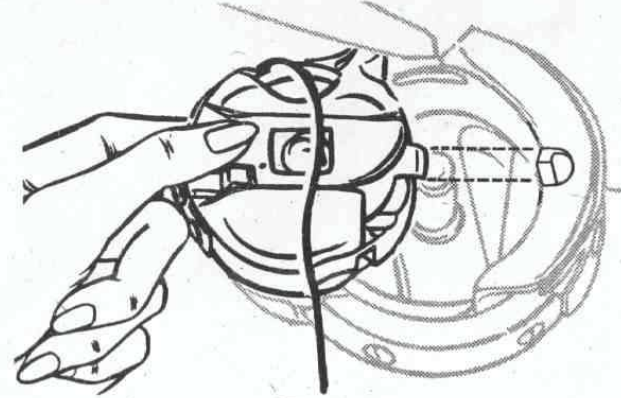
*Fig. 19***TO REPLACE BOBBIN CASE***Fig. 20*

3. Grasp bobbin case between left thumb and forefinger at latch hinge point as shown.

Tilt right edge of bobbin case slightly to engage post.

*Fig. 21*

4. Release bobbin case and press forefinger against bobbin case until it snaps in place as shown.

FOR ALL-PURPOSE STITCHING

This SINGER Class 319K machine comes equipped with five built-in stitch designs, one removable FASHION Disc, an All-purpose Throat Plate 105291, and an All-purpose Hinged Presser Foot. This throat plate and

presser foot have the same wide opening to accommodate the swing of the needle. With the equipment listed below, the machine can perform straight, zigzag or ornamental stitching.

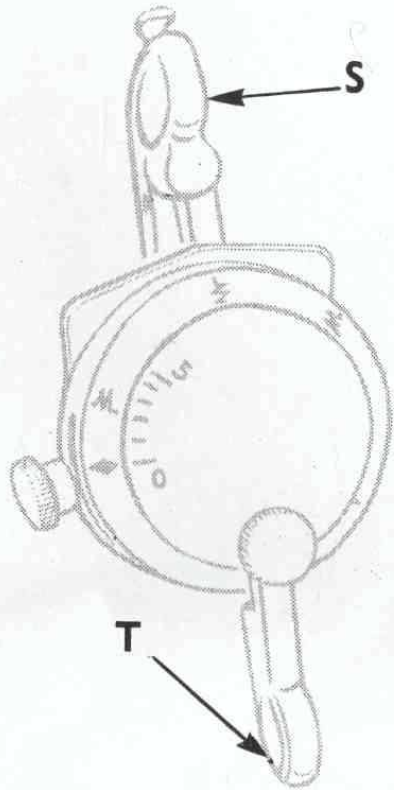

Fig. 22. Bight Control Set for Straight Stitching

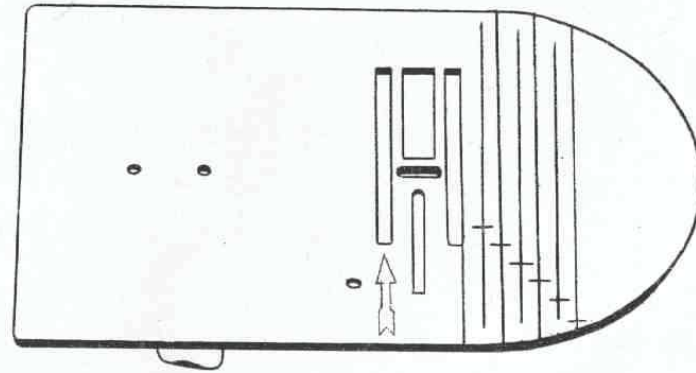

Fig. 23.

All-purpose Throat Plate with guide lines for seam width gauged from centre of needle hole and cross lines for gauging square corners.

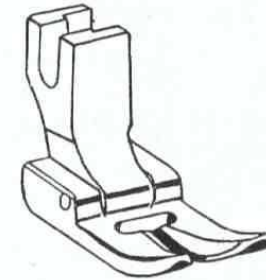

Fig. 24. All-purpose Hinged Presser Foot

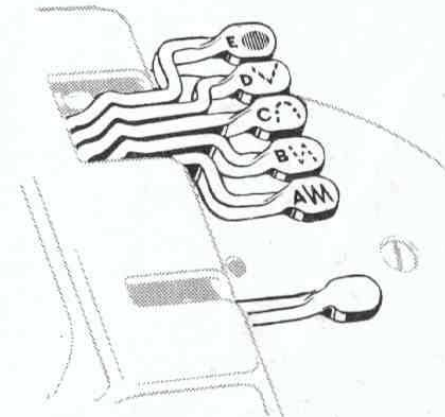

Fig. 25. Stitch Levers A, B, C, D, E

TO PREPARE FOR SEWING

STRAIGHT STITCHING—Set needle position lever **S** and bight lever **T** as shown in **Fig. 26**. Set stitch levers in downward position, as shown in **Fig. 27**.

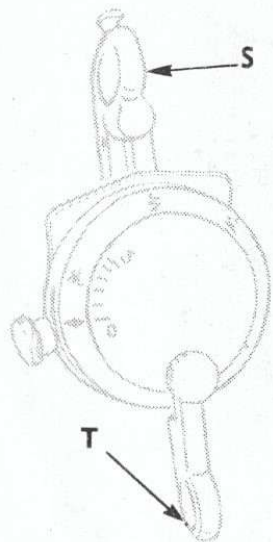

Fig. 26

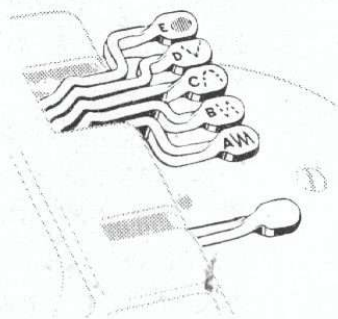

Fig. 27

ZIGZAG STITCHING—Set bight lever as desired between **1** and **5** as shown in **Fig. 28**, and lift Zigzag Lever **A**, as shown in **Fig. 29**.

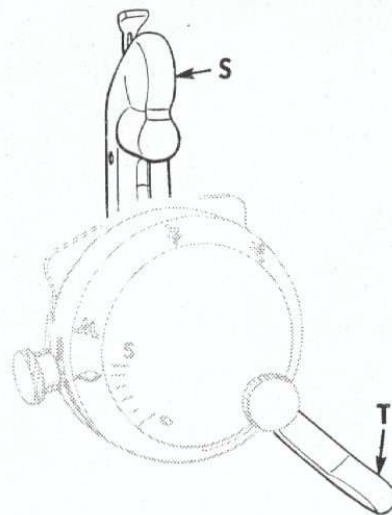

Fig. 28

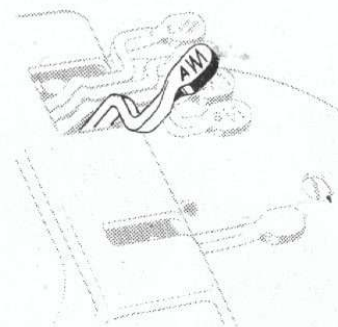

Fig. 29

TO PREPARE FOR SEWING (continued)

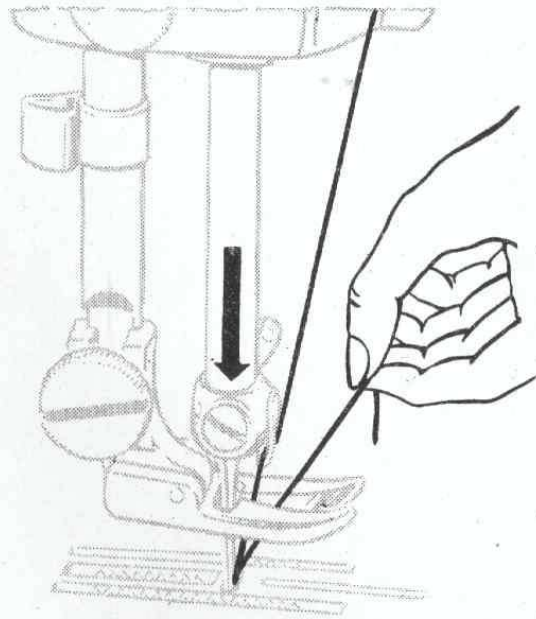

Fig. 30

1. Hold end of needle thread with left hand and turn hand wheel toward you until needle goes down and up again, and take-up lever returns to its highest point.

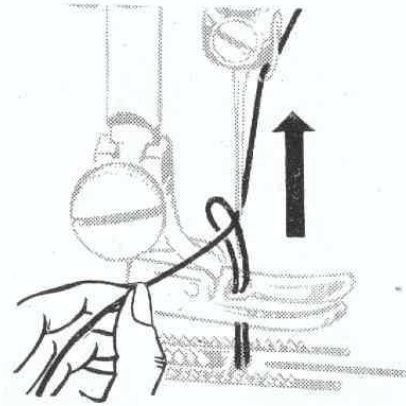

Fig. 31

2. Pull up needle thread and bobbin thread will come with it, as shown in **Figs. 30, 31 and 32.**

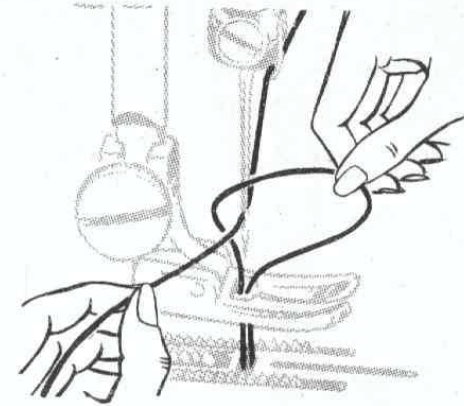

Fig. 32

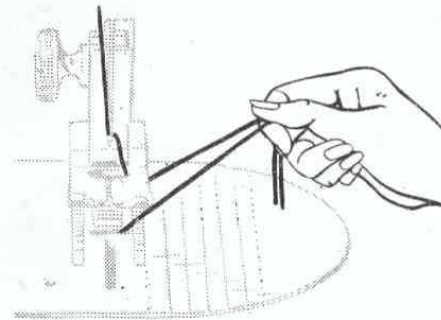

Fig. 33

3. Lay both threads back under presser foot diagonally across feed to the right or left depending upon which side of the needle the material is to be located. See **Fig. 33.** When the presser foot is lowered the threads will be firmly held between the feed and the presser foot.

TO START SEWING

Fig. 34

1. **Bring take-up lever** to its highest point. Place material under presser foot.

2. **Position needle** in the fabric.

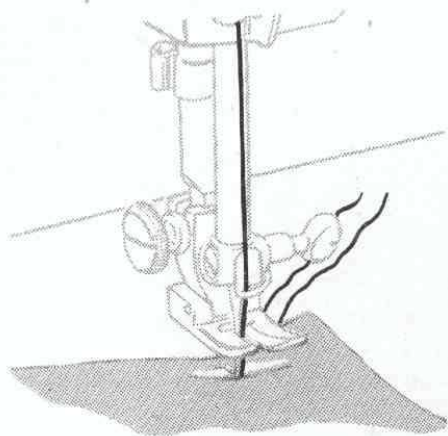
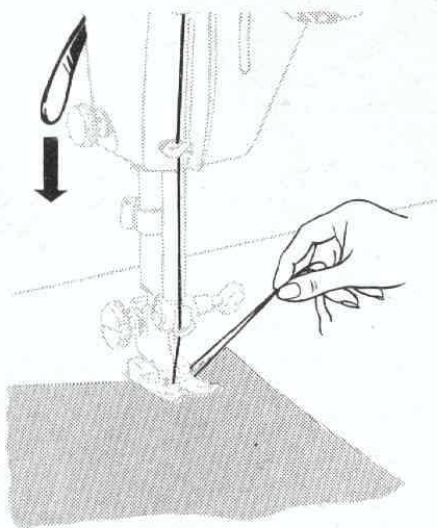

Fig. 35

3. **Lower foot.** Hold threads which have been drawn to the back toward the right under the foot. Press controller pedal to start machine. The speed depends upon the amount of pressure on the controller pedal.

TO REMOVE THE WORK

Fig. 36

Fig. 37

4. **Stop machine** with take-up lever at its highest point.

5. **Raise foot,** draw fabric toward the back and left and sever threads on thread cutter.

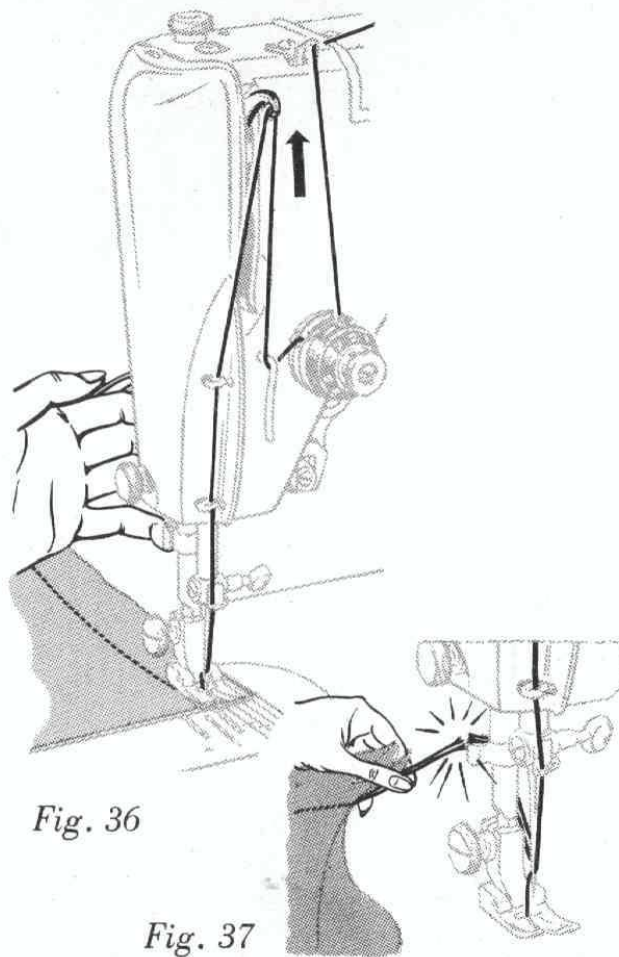
TO GUIDE AND SUPPORT MATERIAL

To avoid uneven tension, length of stitching and distorted seams, **never pull the material when sewing.** Never operate the machine without material under the presser foot.

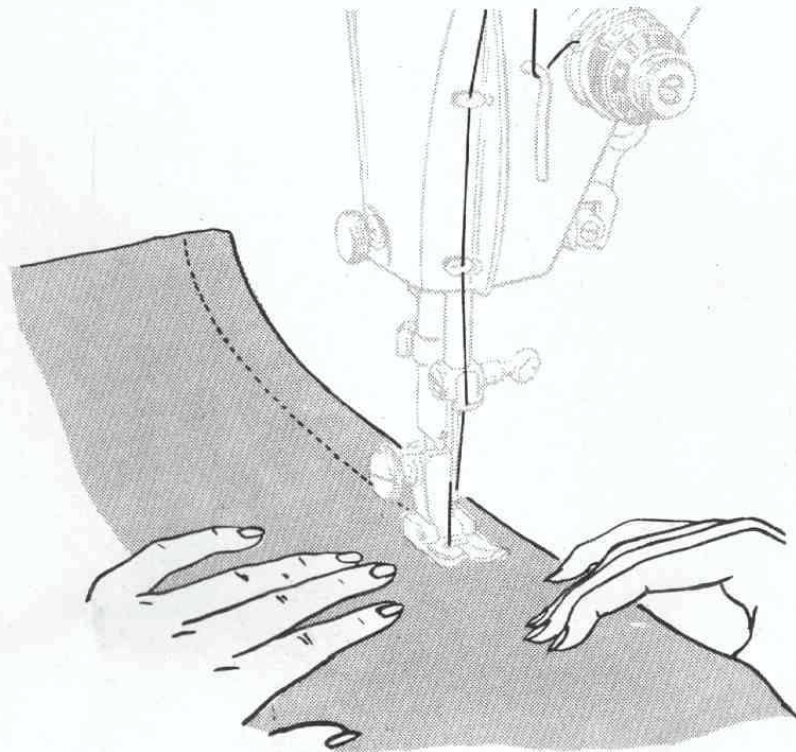

Fig. 38. Guiding Material While Sewing

Most materials require only guiding for best sewing results, as shown above.

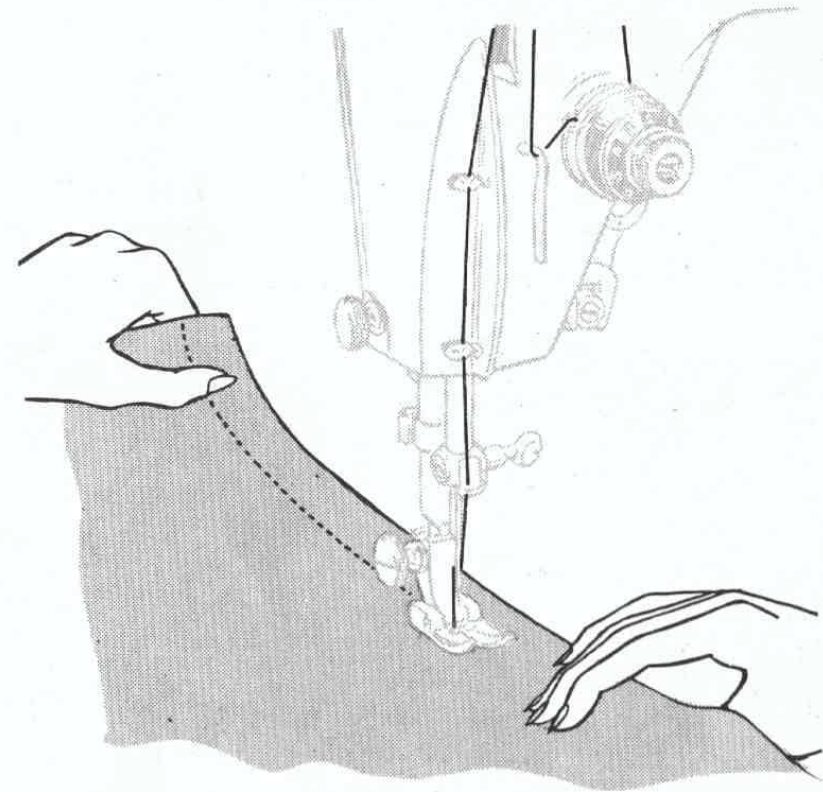

Fig. 39. Supporting Miracle Fabrics

Nylon, Terylene, Orlon, and blends with rayon, puffed weaves, sheers, jersey and tricot which by their nature require light pressure, require support while stitching. This support is given by holding the material taut in back and in front of the foot as the machine stitches and assures a smooth even seam, as shown above.

TO REGULATE LENGTH OF STITCH

Straight Stitching—The numerals on the left of the stitch indicator scale denote the approximate number of stitches per inch.

Zigzag Stitching—The lengthwise distance between needle penetrations is controlled by the stitch regulator.

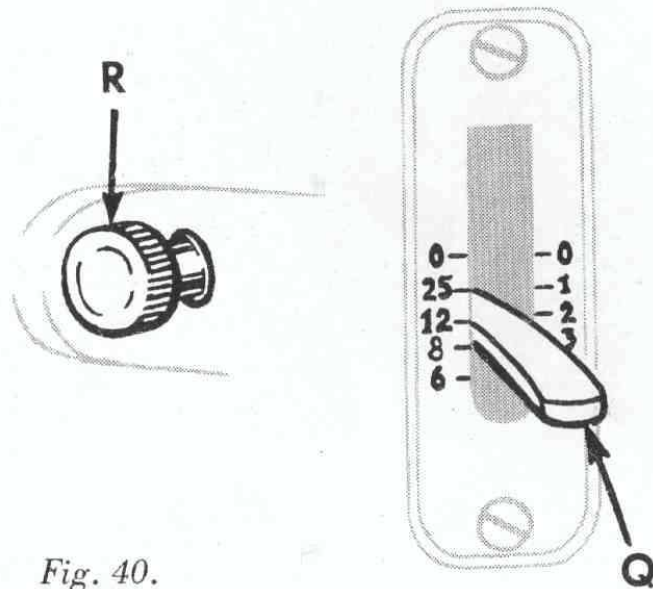

Fig. 40.
Stitch Length Regulator

To lengthen stitch, loosen limit screw **R** enough to allow **top** of stitch regulator lever **Q** to be lowered just below number desired.

Turn limit screw **R** until **top** of stitch lever **Q** rises to setting desired.

To Reverse the Direction of Feed—To feed the material **toward you**, raise the lever **Q**, Fig. 40 as far as it will go. The machine will then stitch in a reverse direction, thus making it easy to “back stitch” and to fasten ends of seams.

STITCH LENGTH FOR SATIN STITCHING



Fig. 41. Satin
Stitch Foot

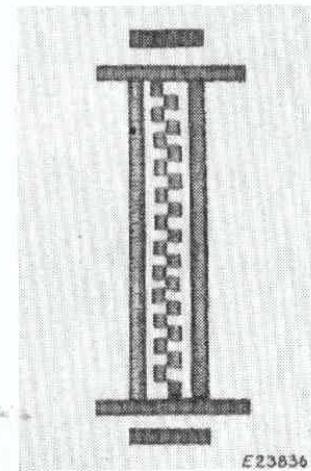

Fig. 42. Satin Stitching

Satin stitching, Fig. 42, is done with stitch regulator lever **Q** set between 25 and 0 position and with the Satin Stitch Foot Fig. 41.

SATIN STITCHING—(Continued)

While stitching on a scrap of material, set stitch regulator lever at 25, then carefully and slowly turn limit screw **R** until stitches are placed closely together, allowing material to feed smoothly and evenly without irregularity.

The exact setting of the stitch length for closed satin stitching will vary with the texture of the fabric, the amount of needle and bobbin thread tension, and with the operator depending upon whether she holds the fabric firmly or lightly. A light tension and light even handling are recommended for satin stitching. Foot 105251 provides a channel for satin stitching and gives smooth uniform results.

Loosely woven or soft fabrics give best results when backed with crisp lawn. This backing is cut away close to the stitching when work is completed.

Where satin or design stitching is to be done on a single thickness of the garment, a backing is essential on most fabrics.

TO START AT GIVEN PLACE IN A DESIGN

Stitch on a scrap of material until that point in the design is reached which is to be reproduced. Remove scrap from under the foot.

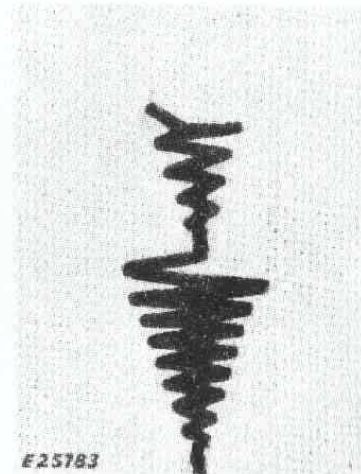
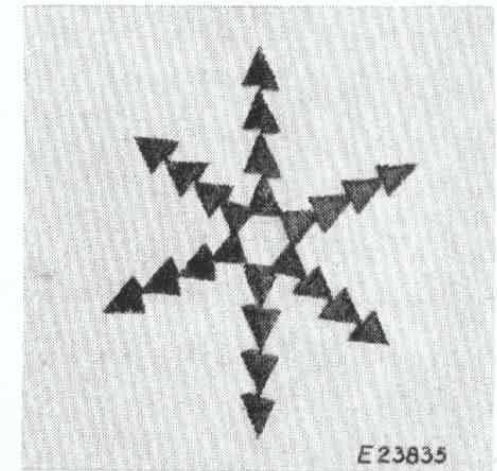
*Fig. 43**Fig. 44*

Place work under needle. Position needle, hold thread ends, drop presser foot and stitch. This procedure is recommended for scalloping and precise design stitching with all FASHION Discs.

BIGHT CONTROL

STRAIGHT STITCHING with straight stitching presser foot, Fig. 46, and straight stitching throat plate, Fig. 45. The small openings in these fittings limit straight stitching to central needle position only. Set bight control at "0" and stitch levers in "down" position.

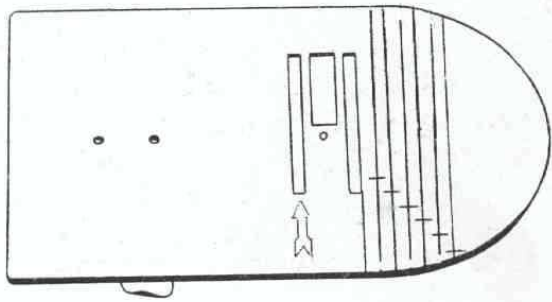

Fig. 45



Fig. 46

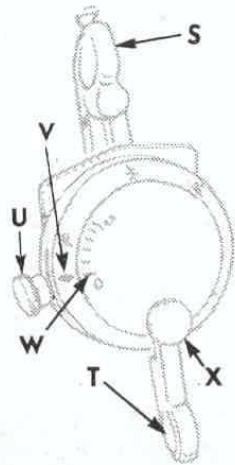

Fig. 47

To lock bight lever **T** for straight stitching bring "0" mark **W** opposite indicator **V**, loosen **MAXIMUM BIGHT STOP SCREW X**, then retighten. Loosen and move **intermediate** bight regulator screw **U** until it engages the notch, then retighten.

ZIGZAG STITCHING must be done with the all-purpose throat plate, Fig. 48, and the all-purpose presser foot, Fig. 49, or any of the special feet which have a wide opening to accommodate the sideward movement of the needle. Lever **A** is lifted for zigzag stitching and the bight lever is set at 1, 2, 3, 4 or 5 depending upon the width of stitch desired. Needle position of right, left or central may be used.

Straight stitching can also be done with this all-purpose equipment.

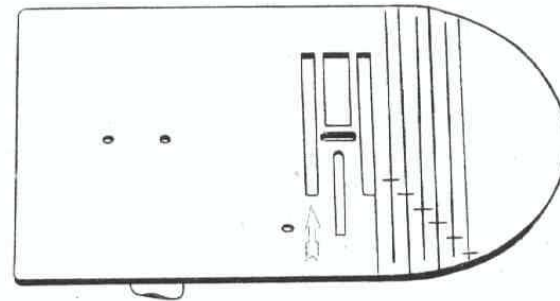

Fig. 48



Fig. 49

AUTOMATIC STITCHING requires the same throat plate and presser feet as for **zigzag stitching**. Levers **B, C, D, E** or any of the added **FASHION Discs** may be used. In addition combinations of levers may be used to produce an unlimited variety of **combination stitches**.

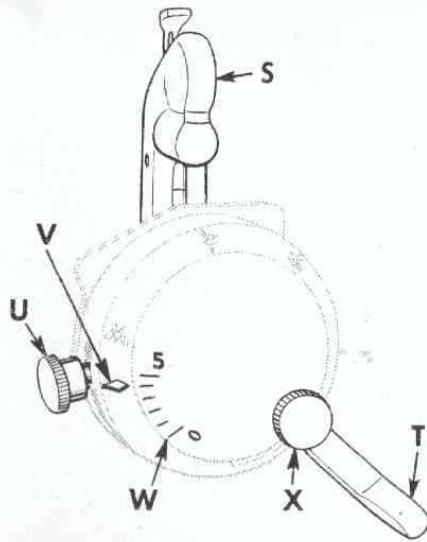

Fig. 50

BIGHT LEVER T, Fig. 50, regulates the width of zigzag stitch or stitch pattern.

BIGHT SCALE is marked "0" to "5". Each line between "0" and "5" denotes the width of stitch pattern obtainable up to a maximum of approximately $\frac{3}{16}$ inch.

BIGHT INDICATOR. Arrow **V** is the mark to which the desired point on the bight scale is set.

ZERO BIGHT is synonymous with straight stitching.
MAXIMUM BIGHT. The machine will sew the maximum width of stitch or stitch pattern when bight lever is set at "5", approximately $\frac{3}{16}$ inch.

MAXIMUM BIGHT STOP SCREW X restricts the movement of the bight lever to a maximum width of stitch less than 5 when set at a given position.

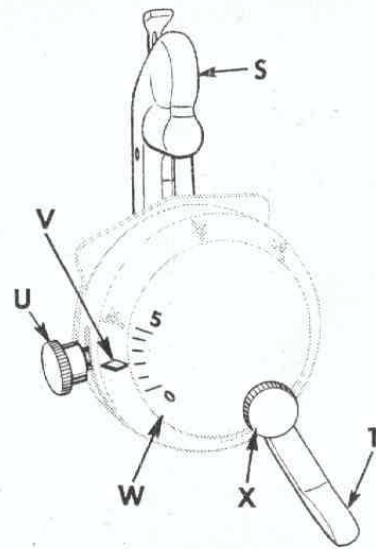

Fig. 51

INTERMEDIATE BIGHT REGULATOR SCREW U, Fig. 51, acts as an intermediate spring-stop for a desired minimum bight. This spring-stop can be passed over to zero bight if desired.

These stops allow you to operate the bight lever manually between set positions without continual reference to the dial while sewing. For example: To limit zigzag stitching between "1" and "4", set bight lever at "4", loosen **MAXIMUM BIGHT LEVER STOP SCREW X**, then tighten. To set minimum position "1", set bight lever so that arrow **V** is at "1", loosen **INTERMEDIATE BIGHT REGULATOR SCREW U** and move it up or down until you feel the notch engaged, then tighten screw **U**. The bight lever is now set to limit the maximum bight at "4" and the minimum at "1". Other limits such as "1" and "3" or "2" and "3" can be obtained in the same manner, see **Fig. 51**.

When free movement of the bight lever is desired between zero and a given bight, screw **U** should be moved down as far as it will go and then securely tightened. Screw **X** is used to limit the maximum bight.

CAUTION: When Straight Stitching Throat Plate 105268 is used, bight lever **T** must be set at 0, needle must be set at central position, and all stitch levers must be down.

Do not make any zigzag stitch, needle position or stitch lever adjustments while needle is in material.

NEEDLE POSITION CONTROL

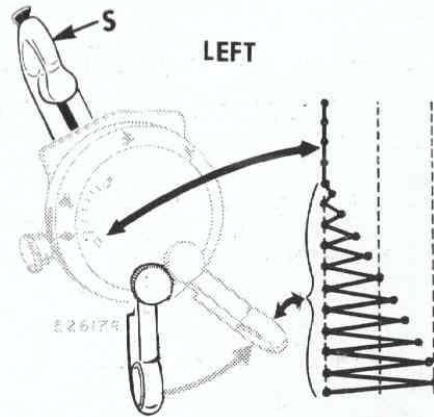

Fig. 52

Fig. 52A

When needle position lever **S** is set to the **left** on the dial, as shown in **Fig. 52**, the machine sews at the extreme left for straight stitching and, as the bight is changed from "0" to "5", the **needle swings from the extreme left**, as shown in **Fig. 52A** for zigzagging.

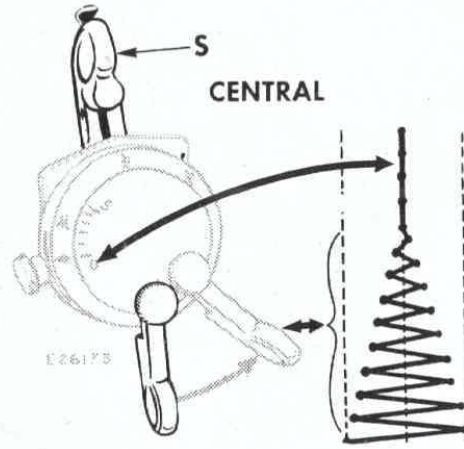

Fig. 53

Fig. 53A

When needle position lever **S** is set at the **central** position, as shown in **Fig. 53**, and as the bight is changed from "0" to "5," the **needle swings equally to the left and right of centre**, as shown in **Fig. 53A**.

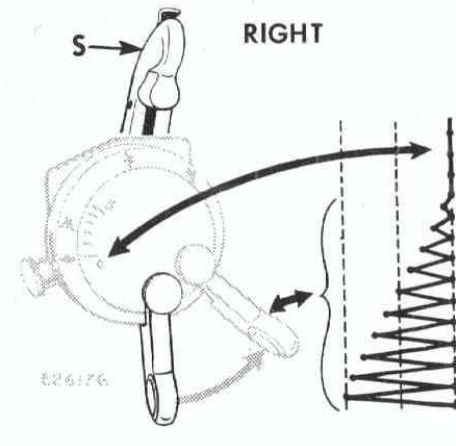

Fig. 54

Fig. 54A

When needle position lever **S** is set to the **right**, as shown in **Fig. 54**, and as the bight is changed from "0" to "5," the **needle swings from the extreme right**, as shown in **Fig. 54A**.

CAUTION: Left needle position, right needle position and stitch levers in "up" position are used **only** with the all-purpose throat plate, for straight stitching as well as zigzag stitching.

Raise needle out of fabric before changing positions of bight control, needle position and stitch levers.

TO CHANGE FASHION DISCS

Raise needle out of material.

Set stitch levers in "down" position.

Remove knurled nut **Y**.

Grasp edges of FASHION Disc **Z** and draw it off shaft.

Place new FASHION Disc on shaft so that pin **A2** engages at slot **B2**.

Replace nut **Y** and tighten securely. To avoid variation in stitching, FASHION Disc must be held in position firmly.

Set bight and needle position levers to desired settings and proceed as for regular sewing.

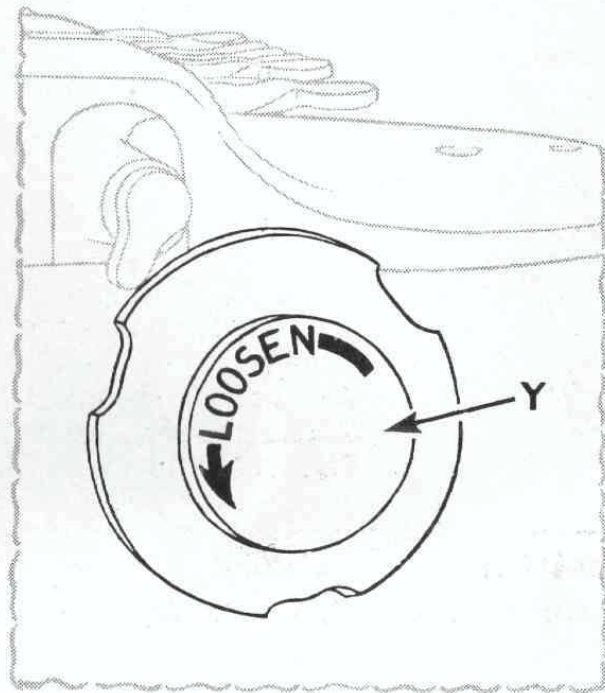

Fig. 55. Step 1. Removing Knurled Nut

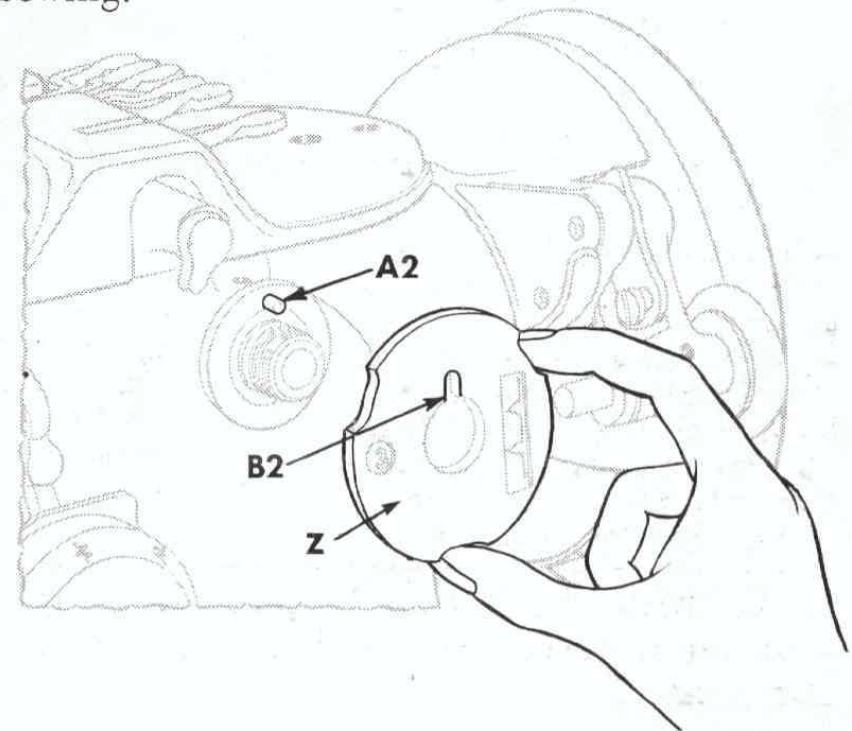

Fig. 56. Step 2. Changing FASHION Disc

TO REGULATE PRESSURE ON PRESSER FOOT

The amount of pressure influences the ease with which you achieve a straight seam and uniform stitching. The pressure should be heavy enough to prevent side creepage of material and light enough to carry the material without marking.

The surface finish on fabrics, as well as their weight, determine amount of pressure to be applied. The glazed surface of chintz and polished cotton, the loose nap surface of satin, the deep piled surface of velvet, the delicate and broken surface of lace and brocade, all require a lighter pressure.

To set a light pressure, turn thumb screw **A2**, **Fig. 57** upward until fabric moves easily under presser foot without slipping and without showing feed marks.

To set a heavy pressure, turn thumb screw **A2** downward until the fabric moves easily and the seam edges are carried evenly by the foot and the feed. Heavy, spongy fabrics like toweling, chenille, coating, etc., require heavier pressure.

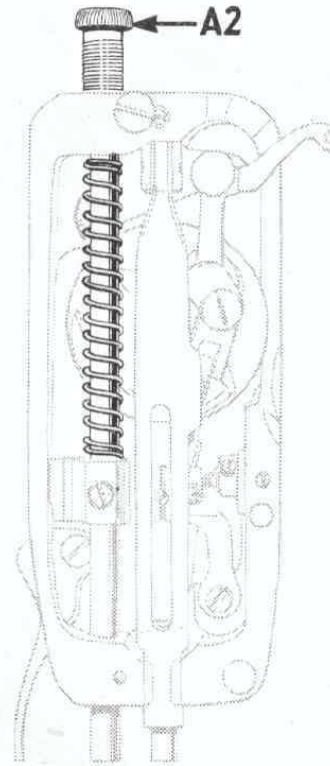

Fig. 57
Thumb Screw
Adjusted for
Light Pressure

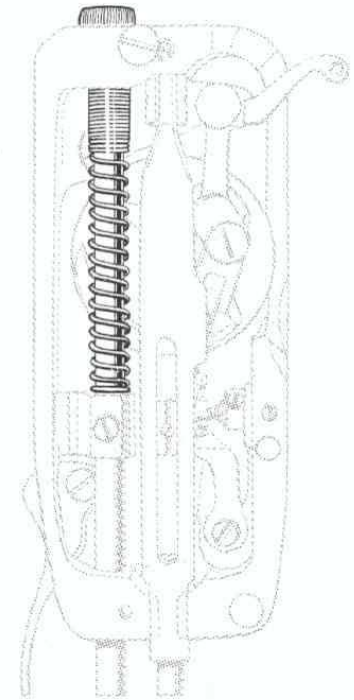
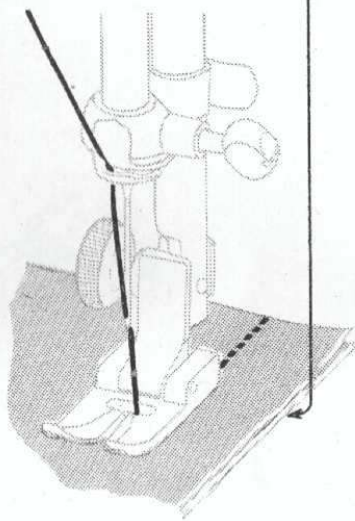
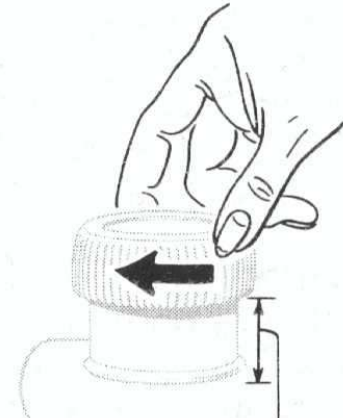
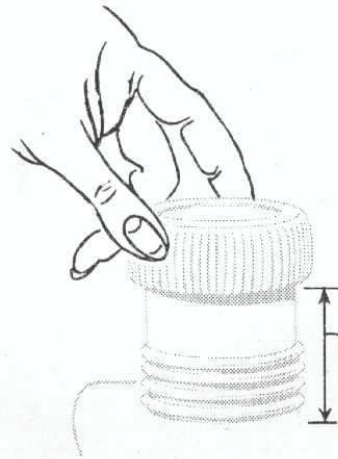
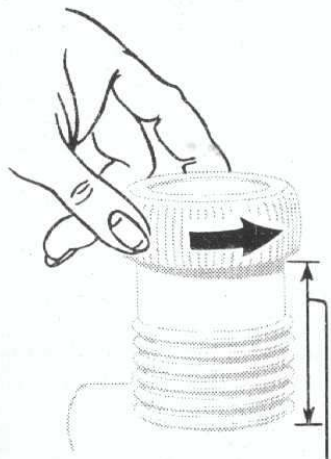
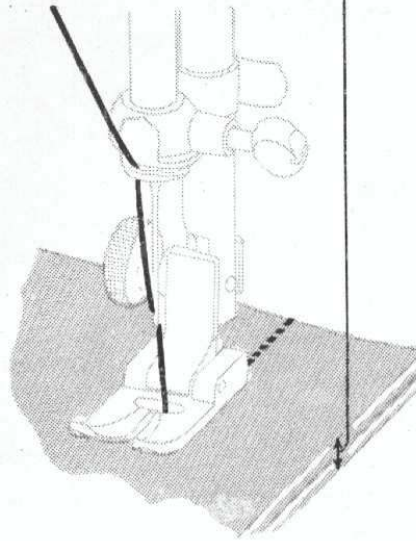
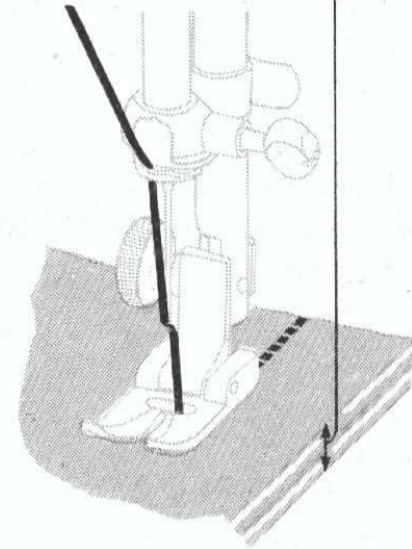

Fig. 58
Thumb Screw
Adjusted for
Heavy Pressure

TO REGULATE PRESSURE ON PRESSER FOOT*Light**Medium**Heavy*

NEEDLE THREAD TENSION

Thread Tensions for Straight Stitching

For perfect stitching, the tension on needle and bobbin threads must be heavy enough to pull threads to centre of material and make a firm stitch.

To Regulate Needle Thread Tension

The tension on needle thread can be tested **only** when presser foot is down.

The numerals "0" to "9" on dial **B2** indicate different degrees of tension that can be obtained. The higher the number the greater the tension. The numbers do not denote size of thread.

When tension has been correctly set for average sewing, note number at indicator line **C2**. This setting may be quickly regained should the tension be altered for special work or change in size of thread.

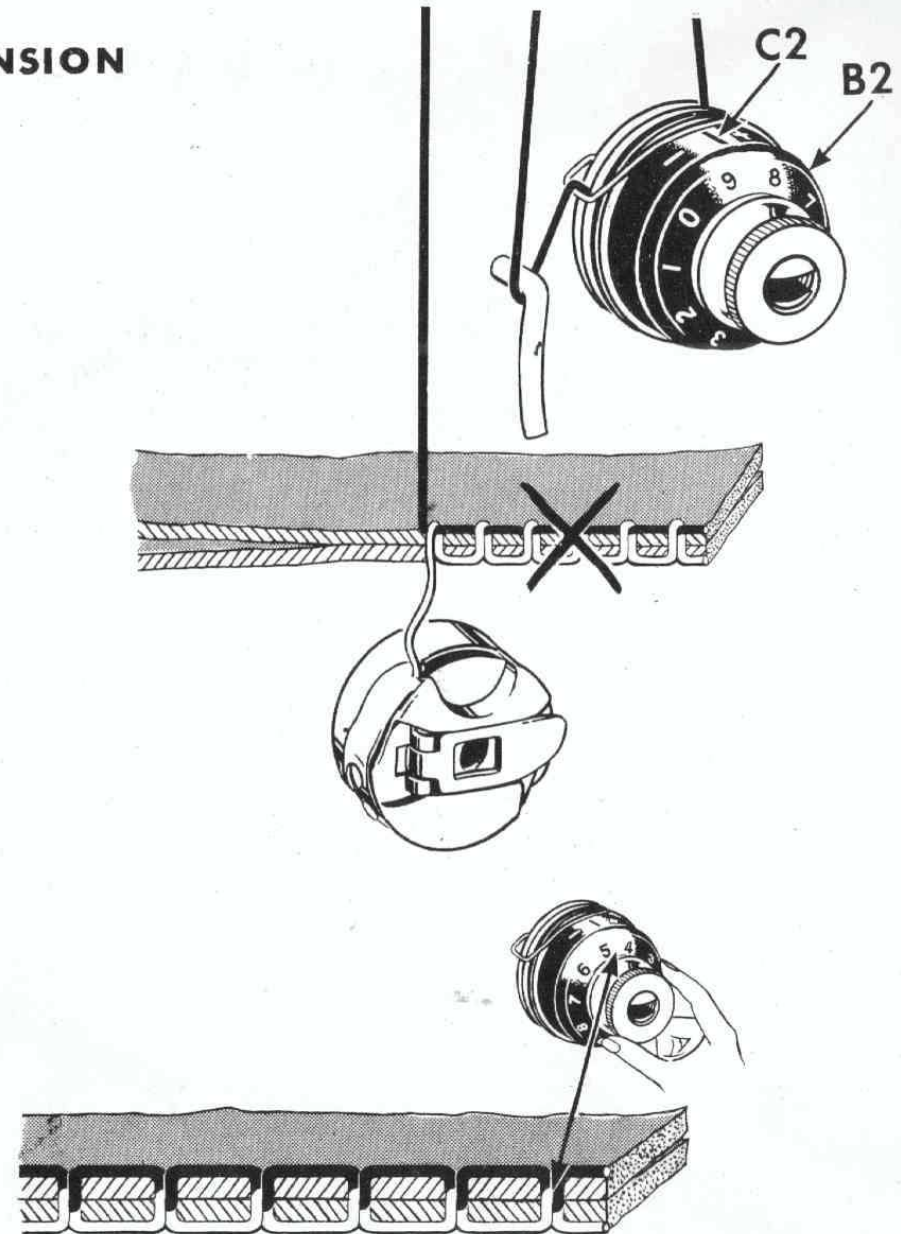

Fig. 59

NEEDLE THREAD TENSION (continued)

In the unbalanced tensions of **Fig. 59**, the needle thread lies straight along top side of material, caused by too heavy tension on needle thread.

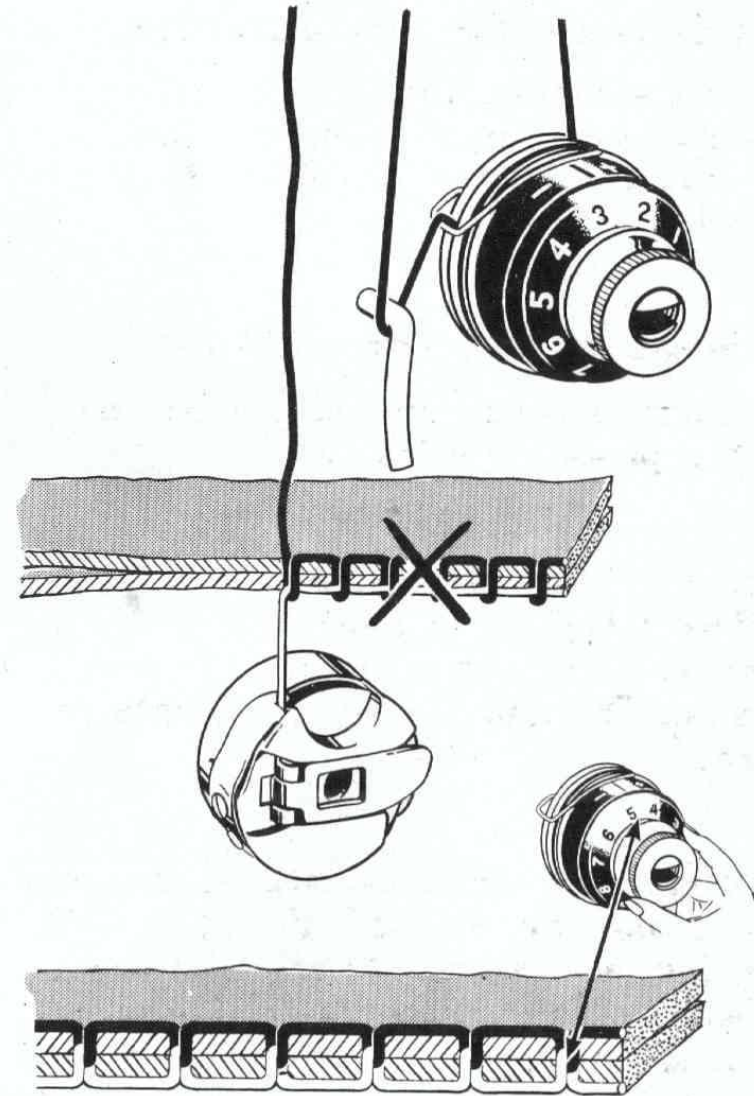

Fig. 60

In the unbalanced tensions of **Fig. 60**, the bobbin thread lies straight along under side of material, caused by too light tension on needle thread.

TO REGULATE BOBBIN THREAD TENSION

The tension on bobbin thread is regulated by the larger screw nearest the centre of the tension spring, as shown in **Fig. 61**.

When adjusting bobbin tension, a slight turn of the screw is all that is needed to make a fine adjustment, because the full range of tension from zero to a maximum is made within $1\frac{1}{4}$ turns of tension regulating screw.

To increase tension, turn this screw gradually over to the right.

To decrease tension, turn this screw gradually over to the left.

The thread tension screw is conveniently adjusted while bobbin case remains in machine.

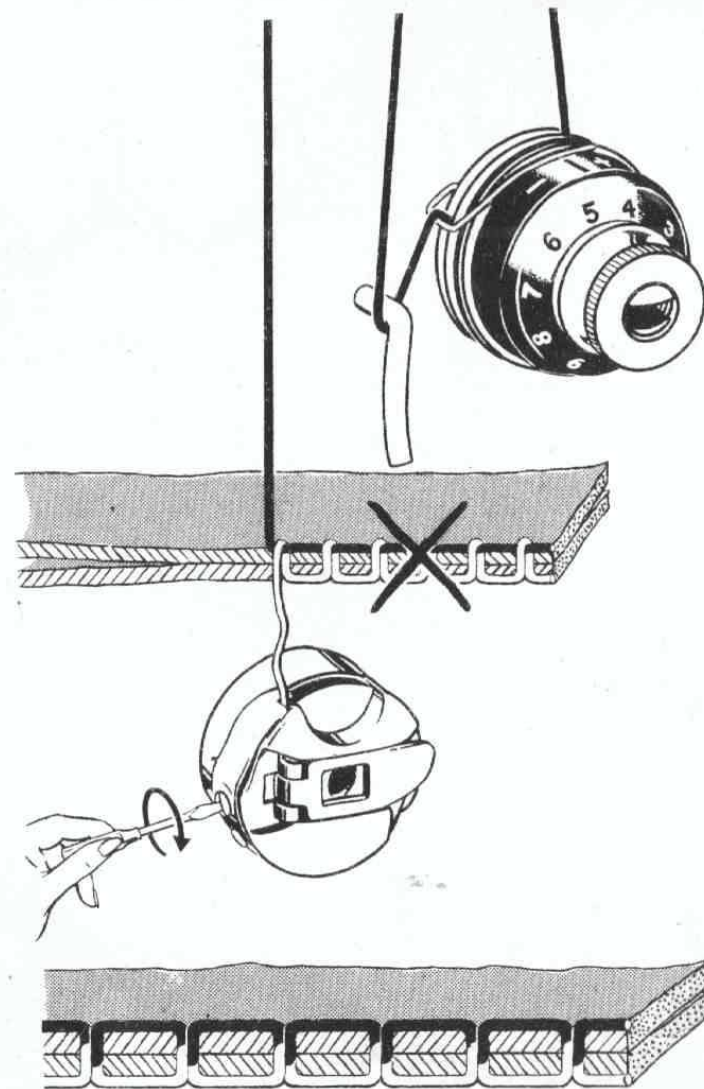

Fig. 61

Bobbin Tension Too Loose

BOBBIN THREAD TENSION (continued)

TO SET BOBBIN THREAD TENSION

Wind bobbin with a 50 yard spool of **fine silk thread**.

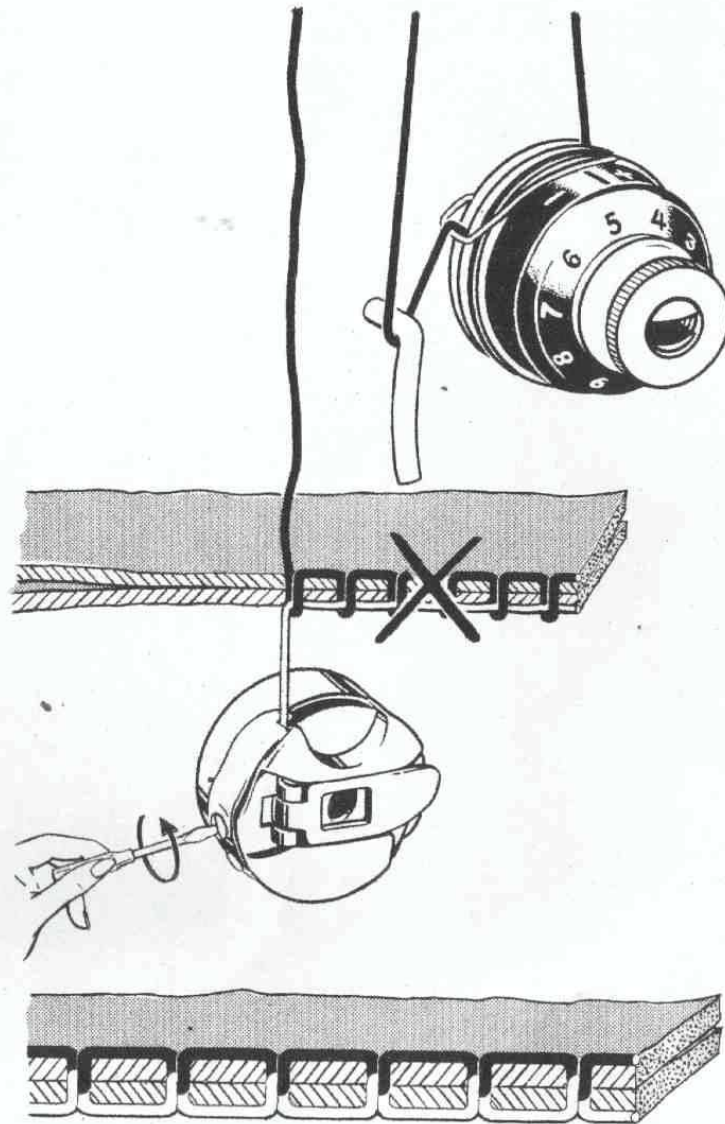

Fig. 62
Bobbin Tension Too Tight

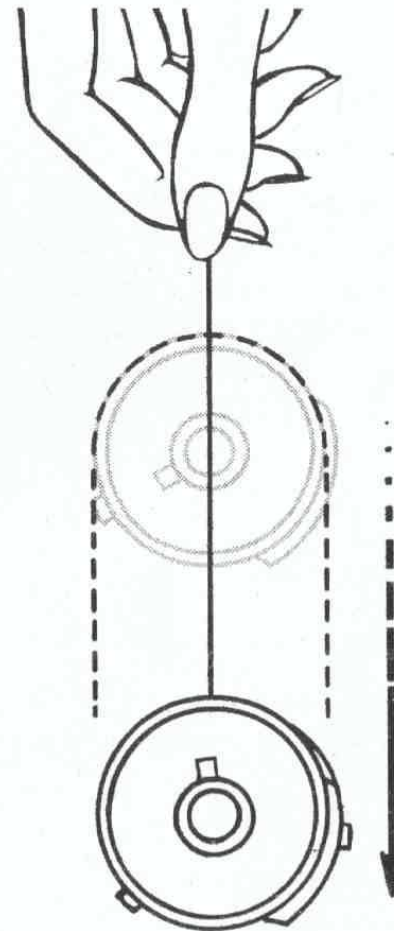

Fig. 63

Thread bobbin case and adjust tension so that weight of bobbin case with a bobbin of 50 yards of fine silk will cause the case to slide slowly, when held suspended by the thread. See **Fig. 63**.

For correct tension, its downward movement should be **very slow**.

Satin Stitching

Satin stitching and solid, closed design stitching require a lighter needle thread tension than for straight stitching or open design stitching.



Fig. 64

At "0" there should be a very slight pull on the thread to indicate there is a minimum tension.



Fig. 65

Wide satin stitching requires the lightest sewing tension. Set the tension dial so the indicator line is between 0 and 2, as shown in **Fig. 64**.

For narrower satin stitching, slightly more tension may be used. Set the dial between 2 and 4, as shown in **Fig. 65**.

NEEDLE THREAD TENSION

Soft fabrics should be backed with crisp lawn or organdie to prevent cording and the dial should be set at 2 or less, as shown in **Fig. 66**.

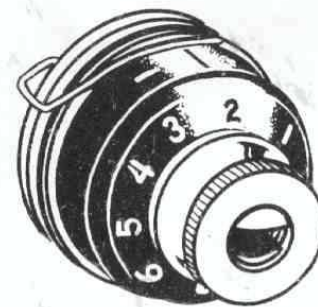

Fig. 66

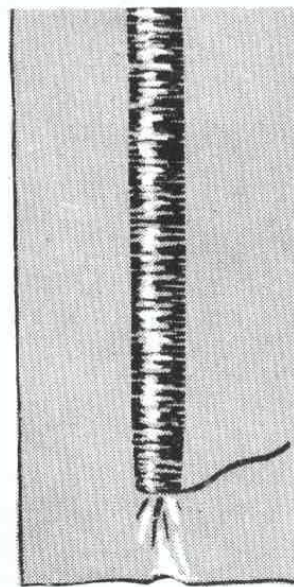

Fig. 67.
*Corded Satin
Stitching resulting
from excessive
tension*

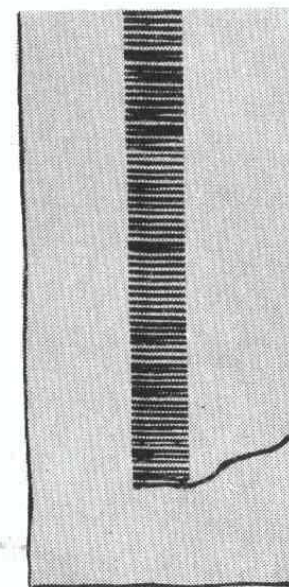

Fig. 68.
*Smooth Satin
Stitching Produced
with correct
tension*

SHOULD IT BECOME NECESSARY TO REMOVE AND DISASSEMBLE NEEDLE THREAD TENSION

Turn thumb nut **E2** to the left (counter-clockwise) until "O" on dial **G2** stops at centre line on indicator **L2**. To separate pin **F2** in thumb nut **E2** from dial

G2, press in dial, unscrew thumb nut and remove it. Then remove tension parts from stud **N2**, as shown in Fig. 69. Do not remove stud **N2**.

TO REASSEMBLE AND REPLACE NEEDLE THREAD TENSION

Make sure that tension releasing pin **R2** is in place in stud **N2**. Replace the tension parts on the stud **N2** as follows: Replace the three tension discs **M2** with the thick flat disc separating the convex surfaced discs. Then replace the indicator **L2**, open side out, on stud with plus and minus signs at top, then insert tension spring **K2** in indicator with the first (half) coil of this spring straddling the lower half of the stud. Place stop

washer on stud with extension **J2** above stud, so that it clears the first (half) coil of tension spring. Next, place dial **G2** on stud with No. 2 opposite stop washer extension **J2**, then push dial to compress tension spring and at the same time screw thumb nut **E2** on stud, inserting pin **F2** on nut in one of the holes in dial **G2**. Then lower presser bar and turn thumb nut **E2** to left until "O" on dial **G2** stops at centre line on indicator **L2**. Thread the tension and pull thread through tension discs to test amount of tension on thread at "O" position.

At this point there should be a slight pull on the thread to indicate that there is a minimum tension which gradually increases with the turning of thumb nut **E2** to the right, providing a full range of tensions with one revolution of the thumb nut. If the pull is too strong for a minimum tension, press in dial **G2** to disengage pin **F2** on nut from dial, and

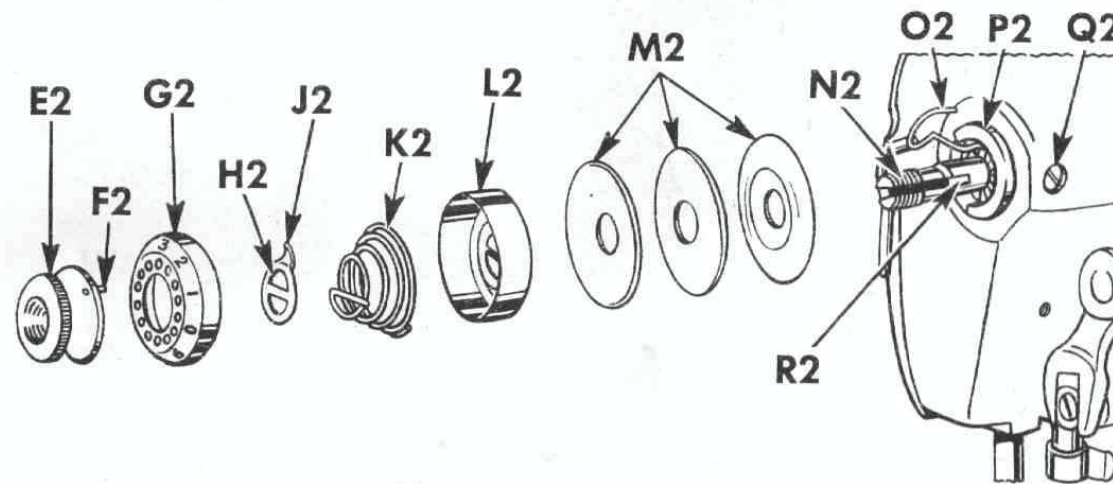

Fig. 69. Needle Thread Tension Assembly

reset pin in one of holes at **left** of previous setting. This resetting will produce less tension at "0". Repeat this process until minimum desired tension is obtained.

If there is no tension at "0", press in dial **G2** and reset pin **F2** on nut in one of holes at **right** of previous setting, repeating this process until a slight minimum tension is obtained. The tension on thread take-up spring **02** and stroke of this spring should be just sufficient to take up slack of needle thread until point of needle reaches fabric in its descent.

To adjust tension on thread take-up spring **02**, remove tension disc assembly, disengage end of spring from groove in tension stud, revolve spring and place its end in the groove which produces correct tension.

To regulate stroke of thread take-up spring **02** loosen screw **Q2**, **Fig. 69**, and turn the thread take-up spring regulator **P2**, **Fig. 69** until correct stroke is obtained, then tighten screw **Q2**.

TO CHANGE THE THROAT PLATE

When changing from All-purpose Throat Plate to Straight Stitching Throat Plate or Embroidery Plate, **FIRST** raise needle to its highest point, set the needle position lever at its central position and set bight lever at "0". Remove presser foot. Tilt the machine head slightly with right hand.

With the left hand tilt the rounded end of throat plate by pressing it up from the underside enough to clear the pin and feed dog as shown in **Fig. 70**. Then draw the plate to the left.

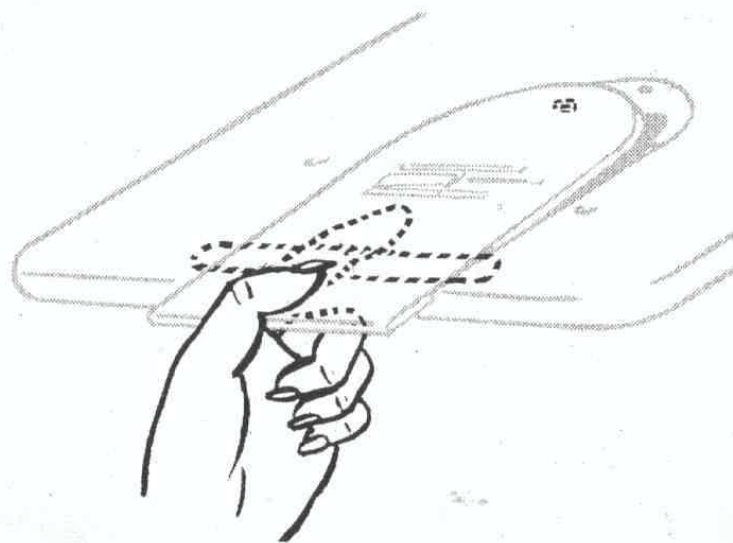

Fig. 70. Changing the Throat Plate

To insert the Throat Plate, slip both ends of its spring beneath the edges of the opening, as shown in **Fig. 70**, and, while it is slightly tilted, slide it over the feed dog, into position.

Lower the machine head into place.

TO SET TWIN NEEDLES

This machine uses a 306x1 Twin Needle in size 3/14. The markings on the needle indicate the spacing (3) and size of the needle (14).

Follow procedure described for setting single needle (see page 17).

CAUTION—Before stitching with Twin Needles be sure the needle position lever is set at central as shown in **Fig. 22, page 23** and that the machine is operated at a bight not exceeding 3. Set bight limit screw **X, Fig. 50, page 31** to lock the bight lever at the point desired but not to exceed 3.

For Twin Needle work the wide slotted throat plate 105291, and the wide slotted all-purpose presser foot 105250 or the satin stitch foot 105251 must be used. Heavy, closely stitched, solid patterns require the satin stitch foot while straight stitching, scalloping or running stitch designs are more effectively done with the all-purpose presser foot. Failure to use the proper throat plate or presser feet with the wide openings will blunt or break needles.

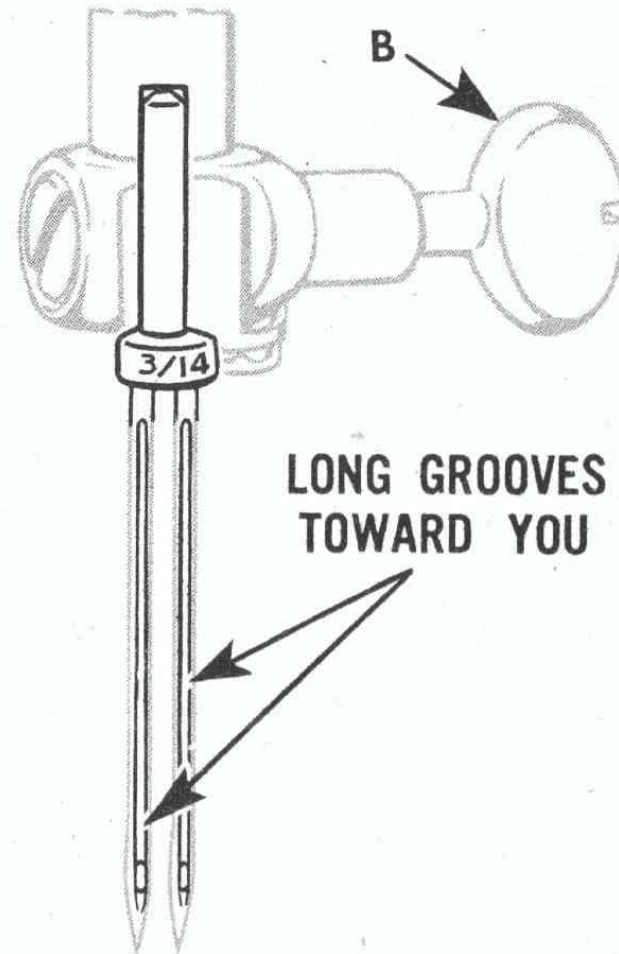

Fig. 71. Inserting Twin Needles Into Needle Clamp

UPPER THREADING—TWIN NEEDLES

Place a spool on each of the two spool pins.

Thread each point with one thread at a time in the same manner as for single needle threading with exception of the tension. **Pass one thread between the rear and centre tension discs and the second thread between the centre and front tension discs.** Thread the eye of each needle from front to back. Threads must not cross or bind each other.

Start to sew with threads positioned in the same way as when stitching with single needle.

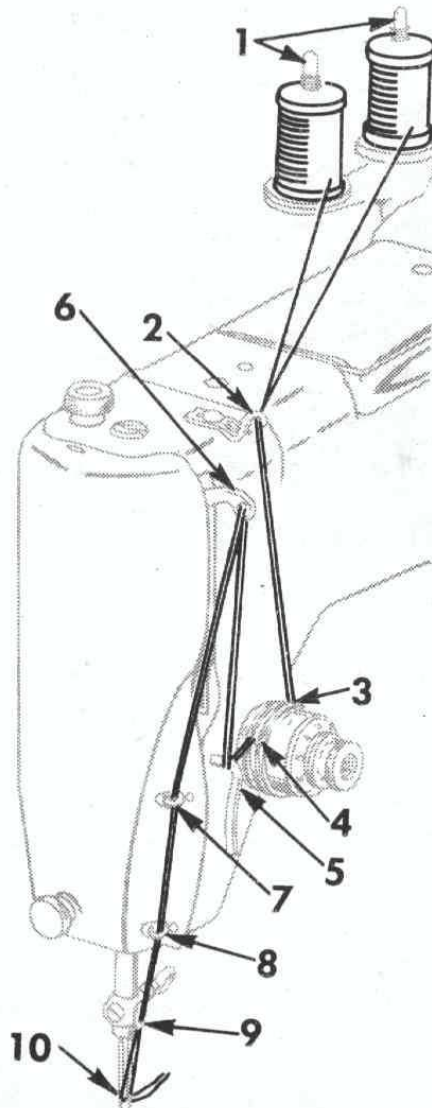

Fig. 72

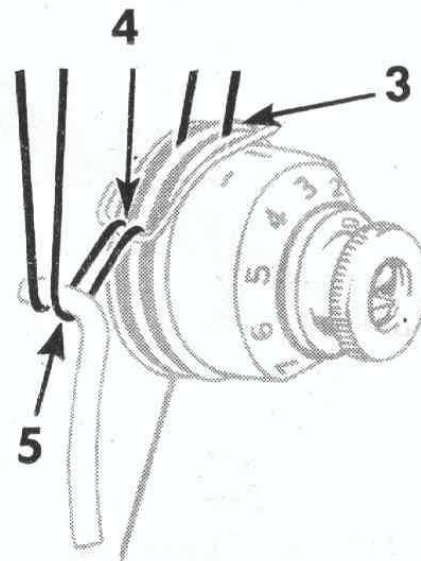

Fig. 73

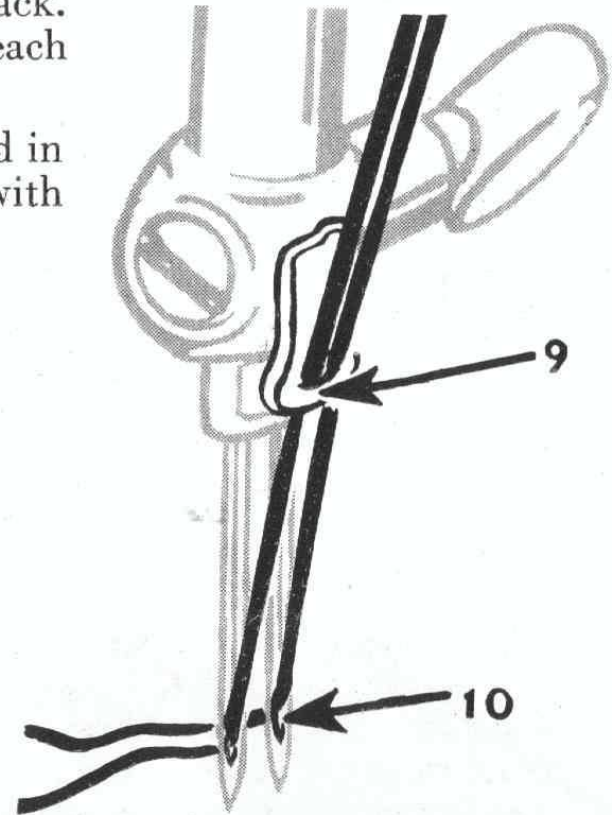

Fig. 74

TWIN NEEDLE STITCHING

Use: All-purpose Throat Plate
All-purpose Presser Foot
Twin Needles

Central Needle Position
0 Bight
12 to 25 Stitch

Simple decorative stitching is effective when used to produce a design of straight or diagonal lines of stitching. The two threads carried by the twin needles interlock with a single bobbin thread and when the tensions are increased the fabric between the lines of stitching is raised.

When stitching parallel lines, spacing should be such that foot does not ride over a previously stitched row, unless when using a special air tucking foot (see Form K6071) with parallel clearance grooves in its sole provided for the air tucks previously sewn.

Square corners are made by turning twice while the needles are out of the fabric.

Stitch until the inside needle has reached the corner. Raise presser foot when needles are out of the fabric. Make a one-eighth turn of the fabric, allowing the inside needle to enter for the second time into the corner stitch penetration. Turn hand wheel until the needles go down and up again and rise out of the fabric.

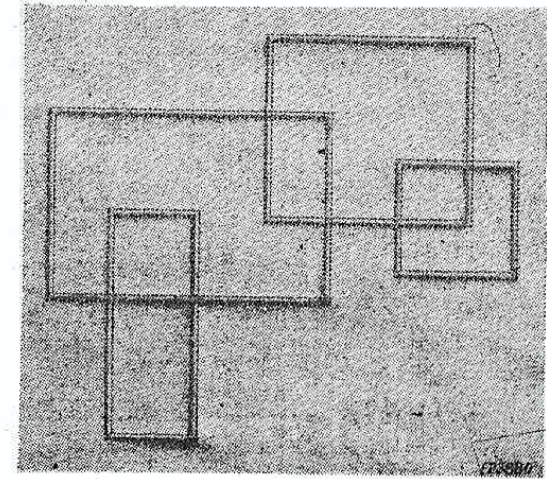

Fig. 75. Twin Needle Air Tucking

Make the second eighth turn of the fabric. Allow the inside needle to enter for the third time into the corner stitch penetration. Continue to stitch in a straight line. When design is completed draw threads to the underside and tie.

Select thread of a size appropriate for the size of needle being used as well as a thread appropriate for the fabric. The Fabric, Thread, Needle and Stitch Length Chart on **Page 16** is a helpful guide.

SEWING SUGGESTIONS

Breaking of needles might be caused by:

1. Wrong size of needle for thread and material—see **page 16**.
2. Wrong throat plate or presser foot for the type of work being done—see **pages 52 and 53**.
3. Wrong setting of needle position lever and/or bight lever—see **pages 24, 30, 31 and 32**.
4. Pulling of material when stitching—see **page 27**.
5. Loosely fastened presser foot or special fittings.
6. Wrong class of needle—see **page 16**.

Breaking of needle thread might be caused by:

1. A knot in thread.
2. Thread too coarse for needle—see **page 16**.
3. Wrong threading—see **pages 18 and 44**.
4. Upper tension too tight—see **pages 36 to 42**.
5. Needle blunt or bent.
6. Needle set incorrectly—see **pages 17 and 43**.
7. Roughened hole in throat plate.
8. Wrong arrangement of threads when starting to sew—see **page 25**.
9. Needle thread tension too light.
10. Damaged sewing hook.

Breaking of bobbin thread might be caused by:

1. Wrong threading of bobbin case—see **page 22**.

2. Bobbin thread tension too tight—see **pages 36 to 42**.
3. Bent Bobbin.
4. Damaged Bobbin Case.

Skipping of stitches might be caused by:

1. Wrong setting of needle—see **pages 17 and 43**.
2. Needle blunt or bent.
3. Needle too small for thread—see **page 16**.
4. Damaged presser foot.
5. Damaged throat plate.

Looped stitching might be caused by:

1. Wrong threading—see **pages 18 and 44**.
2. Tensions set incorrectly—see **pages 36 to 42**.
3. Needle too fine for thread used.
4. Improper presser foot.

Gathering or Puckering of material might be caused by:

1. Failure to use crisp lawn or organdie backing when zigzag stitching with a very wide bight and/or on sheer materials.
2. Excessive needle and bobbin thread tensions.
3. Improper presser foot.

If the suggestions offered here do not correct your sewing problems, call your local SINGER SEWING CENTRE.

PROTECTION AGAINST RUST DAMAGE

Your sewing machine was built to exacting standards of precision and workmanship. Its performance depends on the care and treatment it receives when in use and especially before storing away.

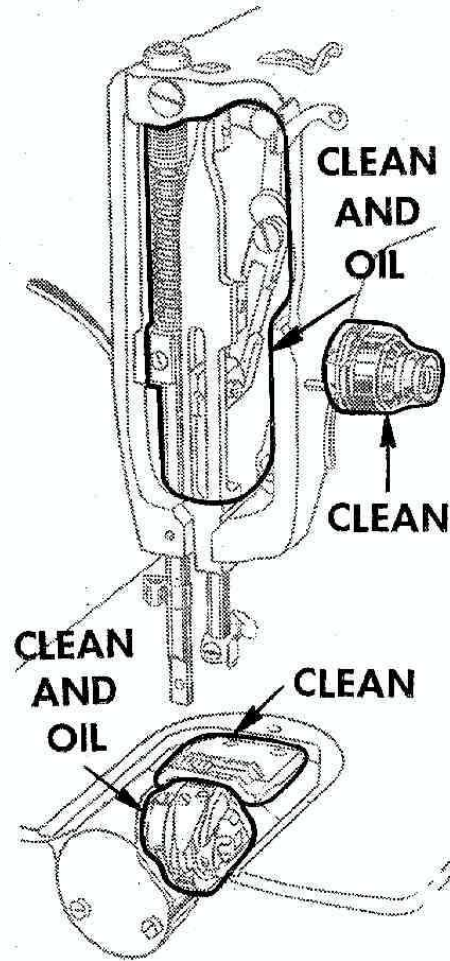

Fig. 75A

Lint and fluff, if not removed prior to storage will, during humid periods, absorb and hold moisture, and thus accelerate rust damage to highly polished thread handling and other exposed parts. The extent of rust damage would depend upon the length of time the machine remained in idle storage in an unventilated closet, attic or basement room.

Sudden drops in temperature will cause moisture to form on parts, which if not protected by a film of oil, would rust and damage while in storage.

Proper storage care suggests thorough brush-cleaning to remove all traces of lint and fluff, followed by swabbing of all the exposed parts with a lint-free brush saturated with SINGER oil. See **Fig. 75A** for the areas that should be cleaned and coated with a protective coat of oil.

TO OIL THE MACHINE

Preparation

Remove face plate and throat plate and swing back cover plate toward hand wheel.

Remove dust and lint with brush.

CAUTION: Do not brush sewing hook with fine bristle brush. (Fine bristles break off and clog the hook.) Use only brush with stiff bristles.

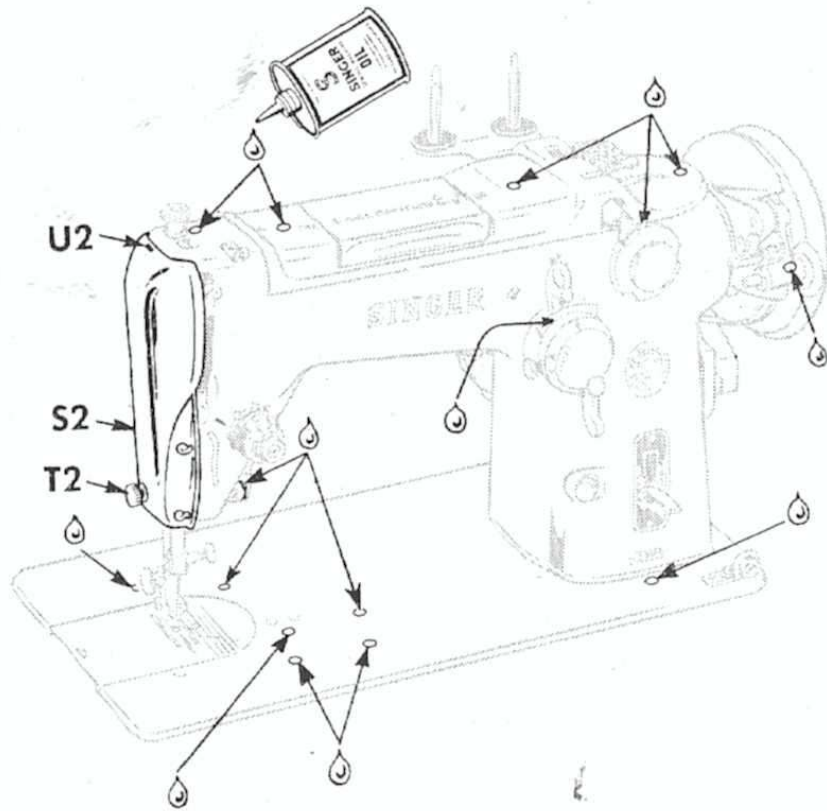

Fig. 76. Front-View, Showing Oiling Points

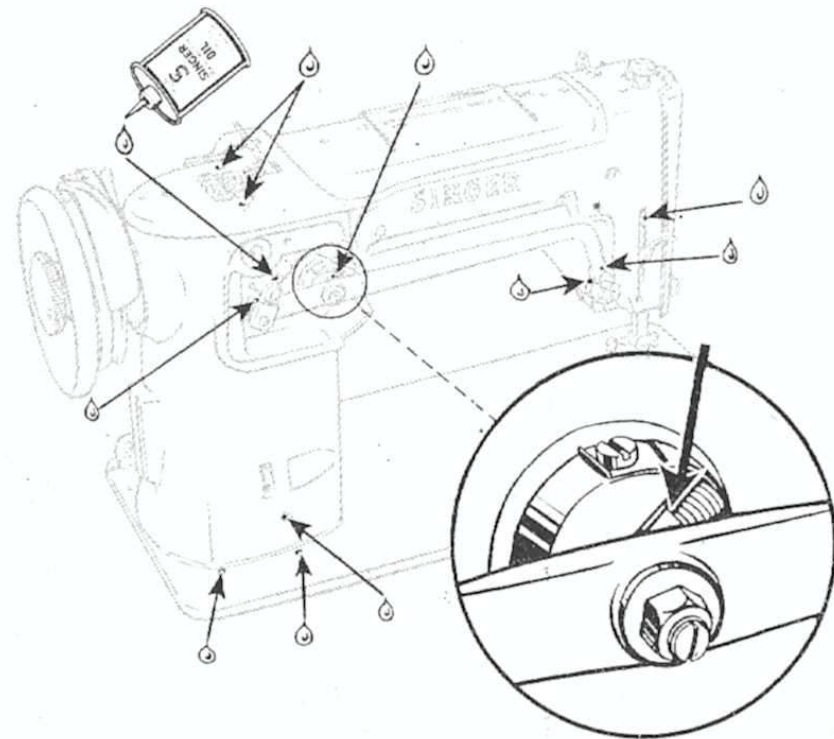

Fig. 77. Rear View, Showing Oiling Points

Oiling

Apply a drop of oil to all points indicated in **Figs. 76, 77, 78, 79 and 80.**

Remove face plate **S2**, **Fig. 76** by taking out thumb screw **T2** and slipping plate up and off screw at **U2**. Oil the points indicated in **Fig. 78** and then replace plate **S2**.

Apply a drop of oil to race of bobbin case holder as shown in **Fig. 79**.

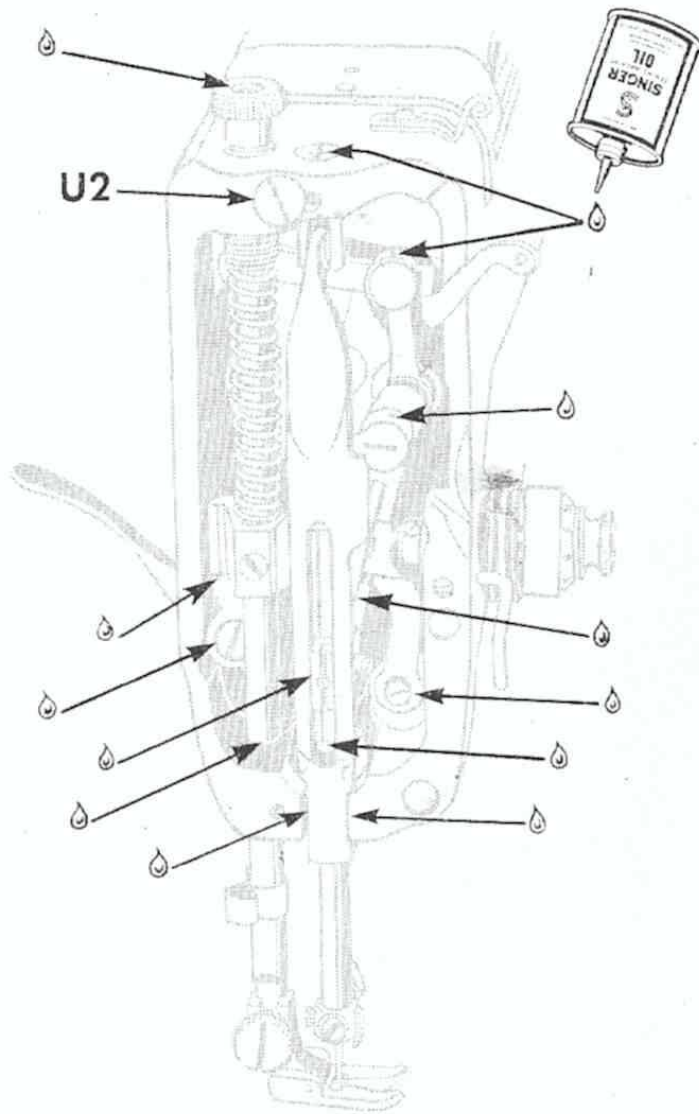

*Fig. 78. Face Plate Removed,
Showing Oiling Points*

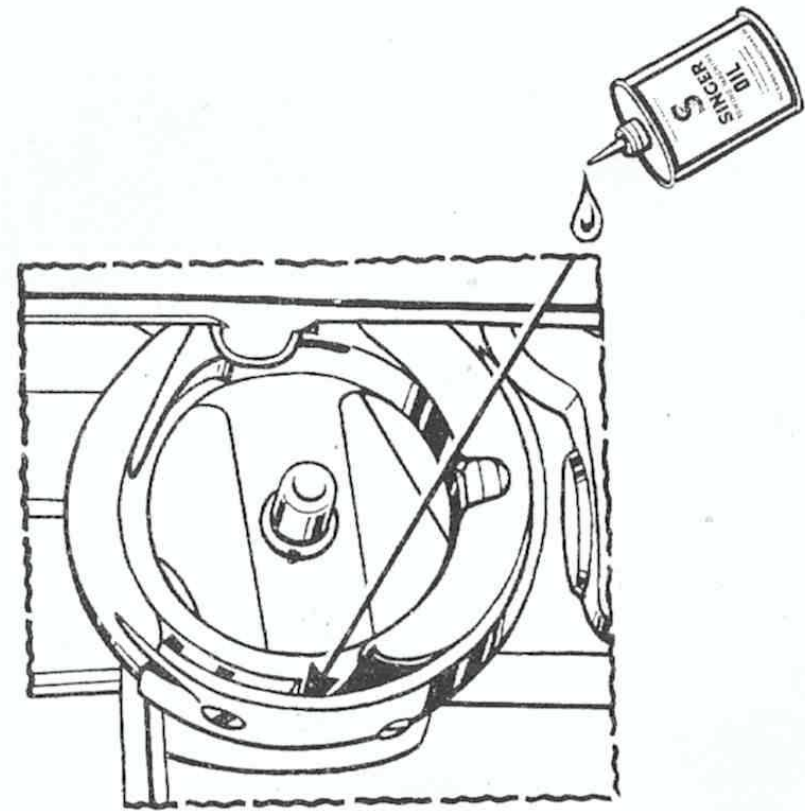

*Fig. 79. Oiling Point in
Bobbin Case Holder*

Turn the machine back on its hinges and oil the places shown in **Fig. 80**.

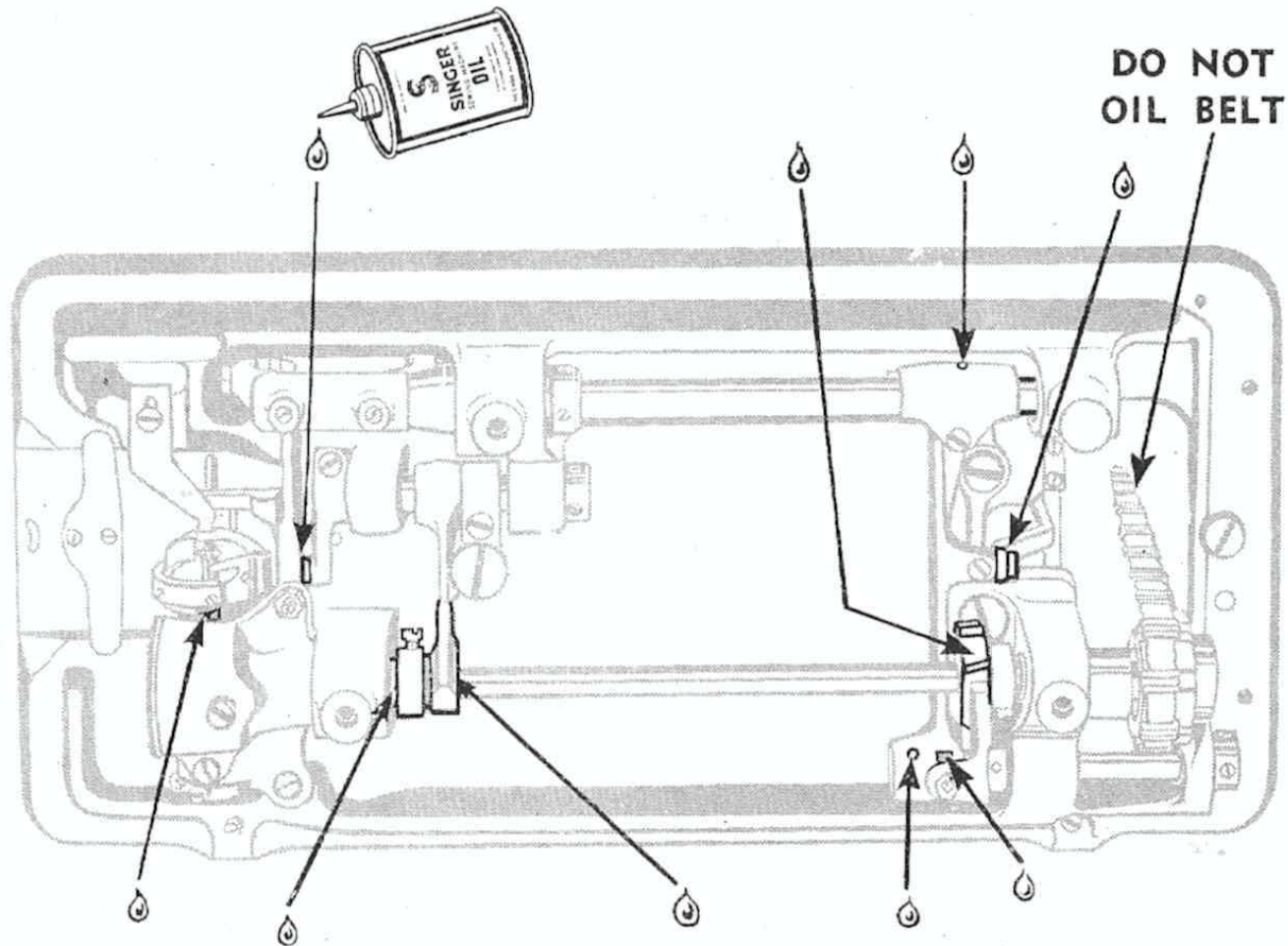

Fig. 80. Oiling Points in Base of Machine

The motor requires no lubrication.

LIGHT**To Turn Light "on" or "off"**

To turn light on reach over machine arm and turn switch **V**, Fig. 81, to right. To extinguish turn switch to left.

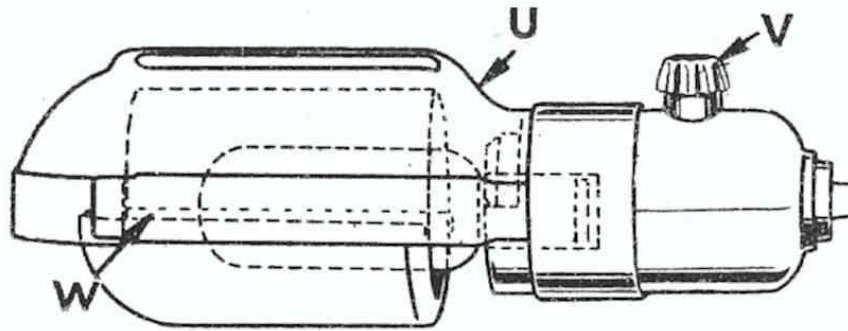

Fig. 81. SINGER Light

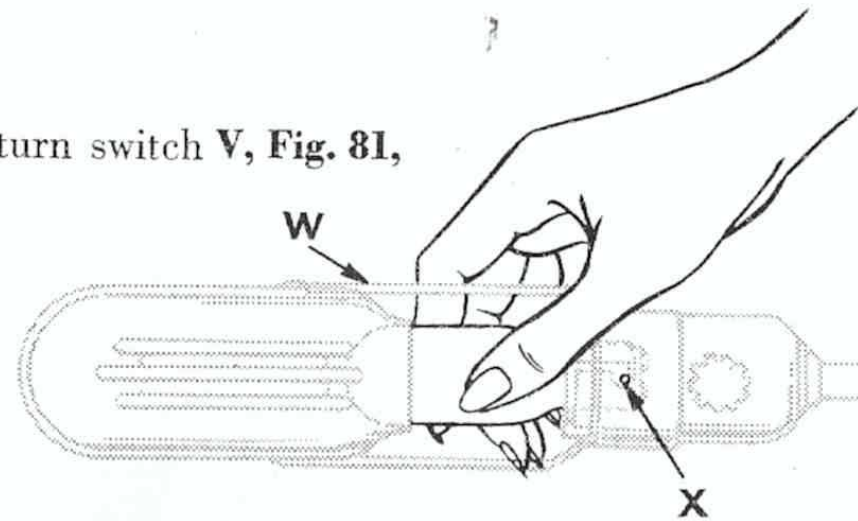

Fig. 82. Removing and Replacing the Bulb

To remove the Bulb

Grasp light socket so that thumb extends over switch **V**. Then press shade with thumb at **U** to release shade from two catches and slide it halfway out of shade holder **W**. Then press bulb into socket and at same time turn bulb over from machine as far as it will go to unlock pin **X** (see Fig. 83). Withdraw the bulb.

To Insert a New Bulb

Press bulb into socket and turn it over toward machine until pin **X** enters notch in socket (see Fig. 83). Return shade to its normal position as shown in Fig. 81.

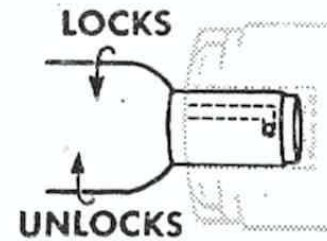

Fig. 83. Locking or Unlocking Bulb Pin

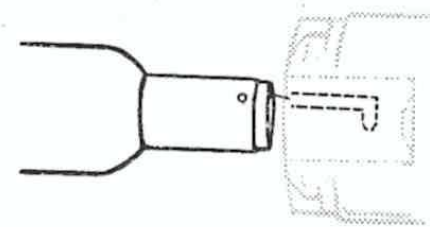
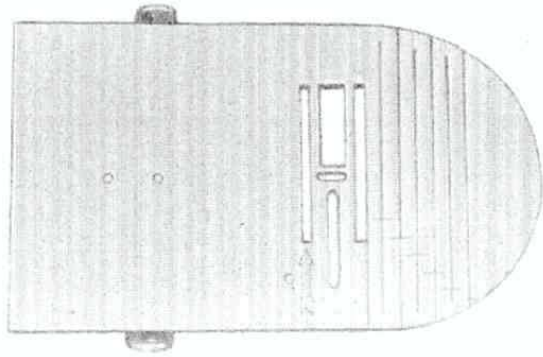
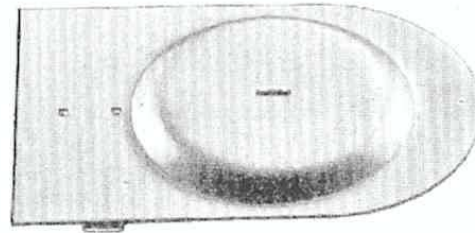

Fig. 84. Inserting Bulb in Socket

ALL-PURPOSE STITCHING EQUIPMENT



105291 All-purpose Throat Plate



189632 Embroidery Plate

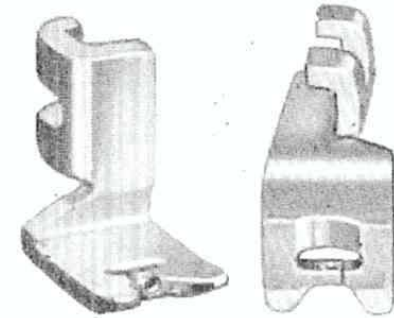

105251 Satin Stitch Foot

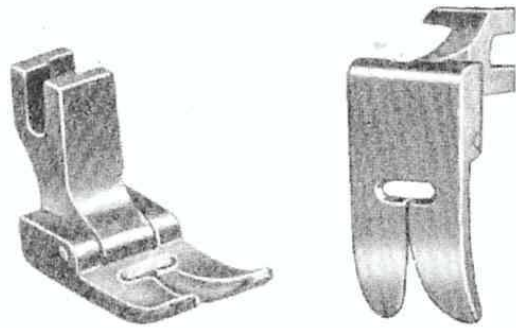

105250 All-purpose Hinged Presser Foot

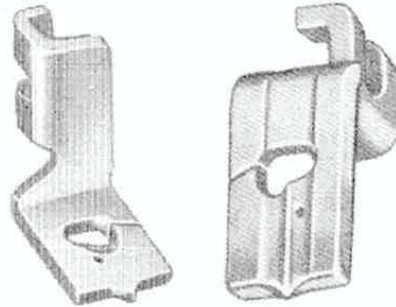

86616 Buttonholer Foot

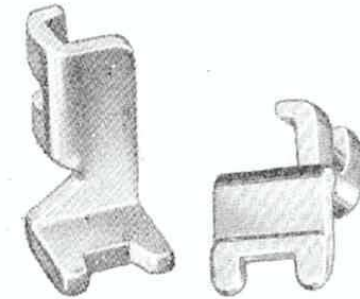

189648 Button-Sewing Foot

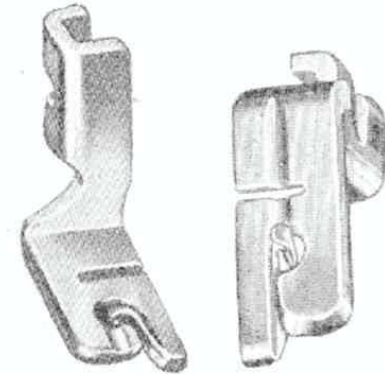

189653 Shell Hemmer

The wide openings in the equipment on this page will accommodate the full range of settings attained by moving the needle position and bight position levers to any point required.

STRAIGHT STITCHING EQUIPMENT

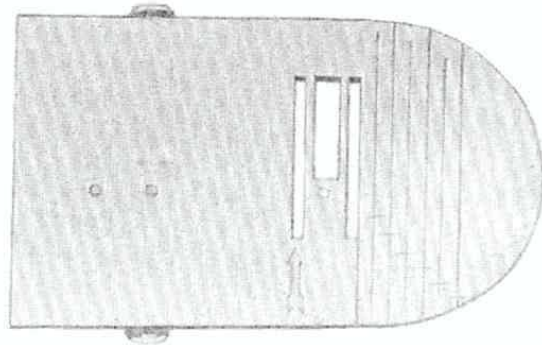

105295 Straight Stitching
Throat Plate

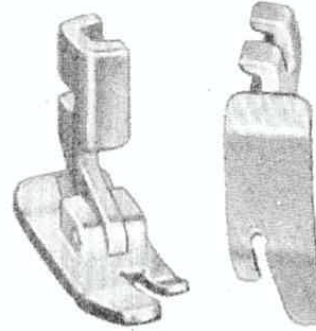

105248 Straight Stitching
Presser Foot

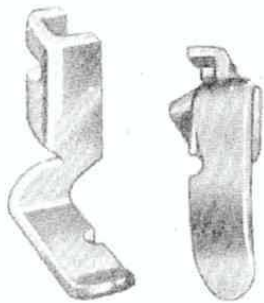

160845 Cording
or Zipper Foot
(Left Toe)

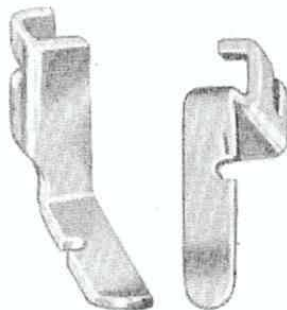

160846 Cording
or Zipper Foot
(Right Toe)

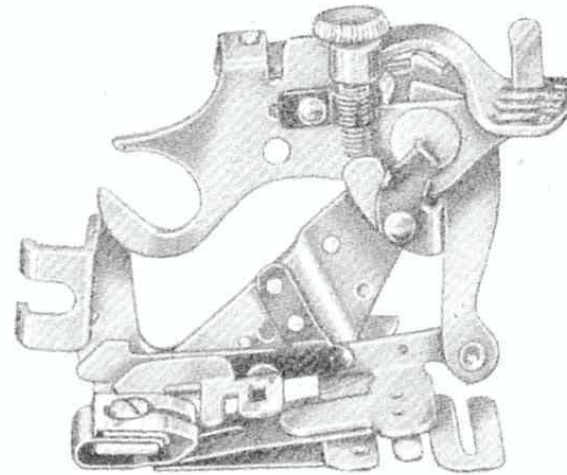

86642 Ruffler

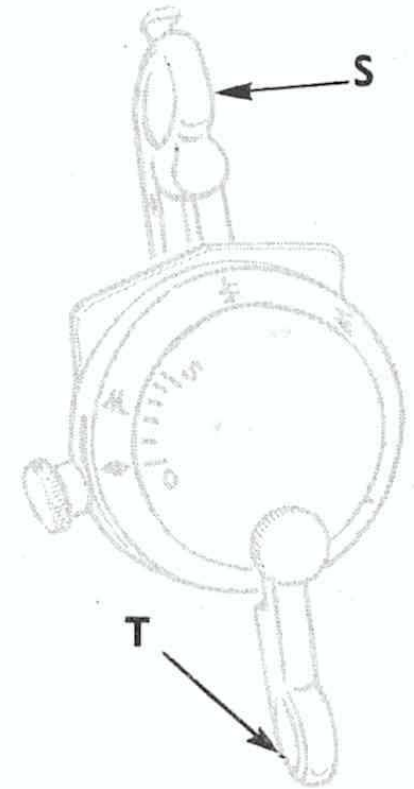

Fig. 85. Machine Set for
Straight Stitching

CAUTION: All of the parts shown on this page are designed for straight stitching **only**. They must not be used for zigzag stitching. Use **only** AFTER needle position lever **S** is set at central position, and bight lever **T** is set at "0", as shown in **Fig. 85**.

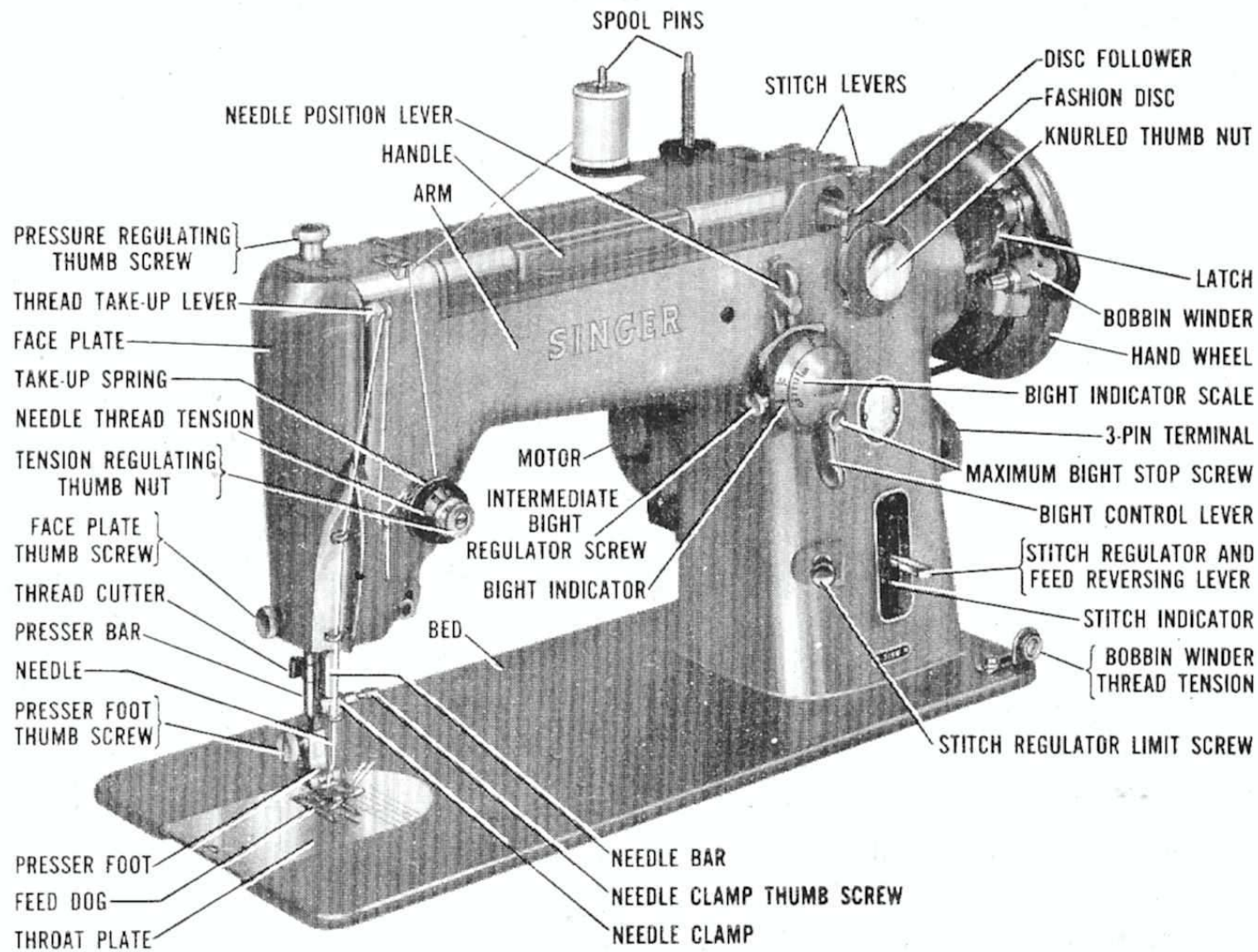

Fig. 86. Names of Principal Parts of 319K Machine

APPLICATION OF SINGER AUTOMATIC TO CONSTRUCTION OF GARMENTS AND FURNISHINGS

STRAIGHT STITCHING

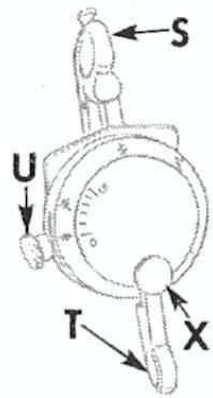

Fig. 87

Straight stitching is accomplished with all stitch levers in a downward position and with the bight set at zero as shown in **Figs. 87 and 88.**

Central needle position is used for straight stitching except in the unusual situation when it is desirable to alter the location of the needle in relationship to the centre of the presser foot.

The Straight Stitching Throat Plate and Straight Stitching Presser Foot are designed to accommodate all fabrics, but especially delicate, soft fabrics, sheers, crepe weaves and all fabrics where the weave or

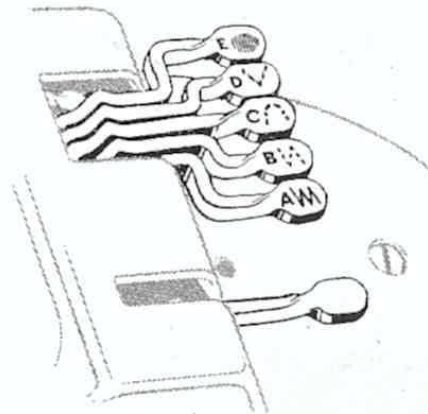

Fig. 88

finish causes the fabric to cling to the needle, either on its upward or downward stroke.

The Straight Stitching Presser Foot is convenient for stitching curved seams, following the edge of a lapped seam, the fold of a pleat or when placing an edge-stitching on a yoke or collar. The narrow right toe affords an excellent view at the right of the needle for such work.

To Lock Bight Control for Straight Stitching. When straight stitching, set needle position lever at central, bight lever **T** at zero and set maximum bight stop screw **X** as shown in **Fig. 87.** Then bring the intermediate bight regulator screw **U** upward or downward until you feel the notch engaged.

Test Stitch. It is a good practice to test stitch on a scrap of fabric before stitching a garment to determine the correctness of tensions, length of stitch and pressure. The Fabric, Thread, Needle and Stitch Length Chart on **page 16,** is a useful guide to the correct needle, thread and stitch length for a wide variety of fabrics.

PLAIN SEAMS—BACK STITCHING

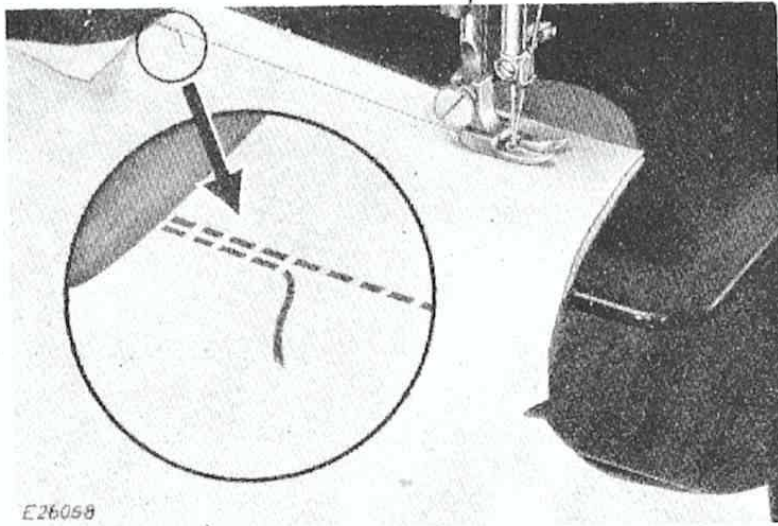

Fig. 89. Seaming Dress Sections

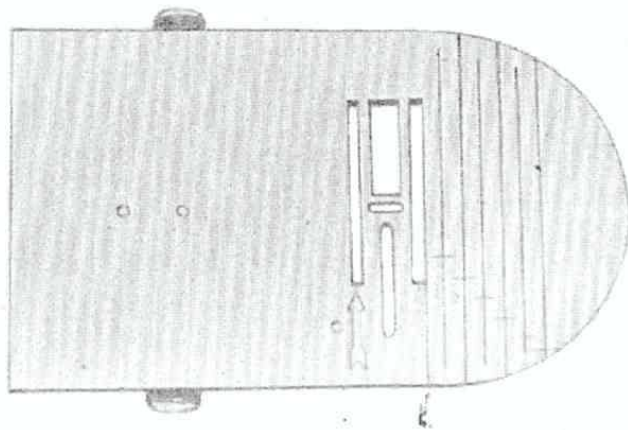
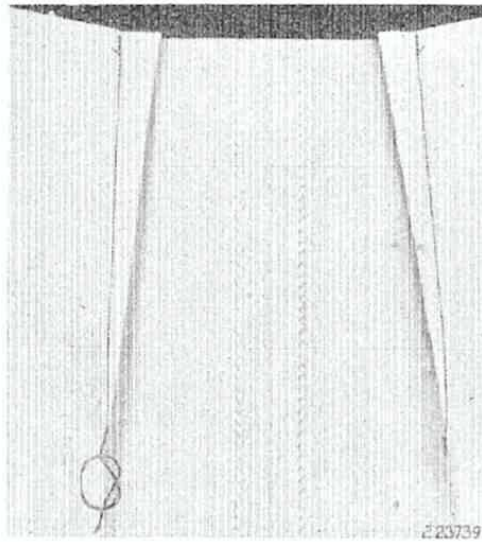

Fig. 90. All-purpose Scored Throat Plate

Plain Seams comprise a large part of general sewing. Seam ends are stayed with back stitching to prevent their opening during fitting and assembling the garment. Position needle a few stitches from the edge of the garment. Hold threads which have been drawn to the back and right under presser foot. Stitch in reverse to the edge and then forward until end of seam is reached. Back stitch again to stay end of seam.

The All-purpose Presser Foot and All-purpose Throat Plate are frequently used for both zigzag stitching and straight stitching and must be used when straight stitching in other than central needle position.

The scoring on the throat plate of your SINGER Swing-Needle makes it easy to guide your stitching an exact distance from an edge. The cross line markings indicate the point at which to pivot in seaming a square corner for each seam width.



*Fig. 91. Dart Thread
Being Tied*

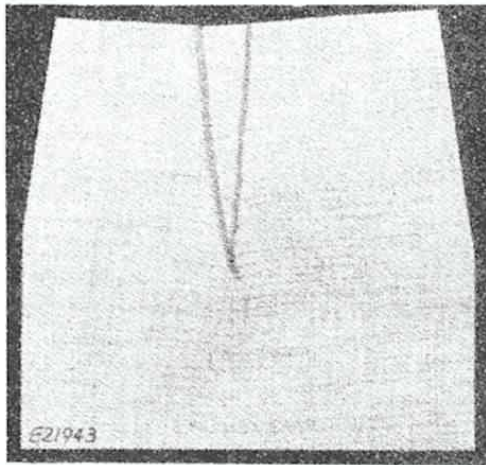

*Fig. 93. Contour Dart
Along Raw Edges*

FITTED DARTS

Darts are conveniently stayed at the points by stitching beyond the fabric about one-half inch to form a thread chain. Tie these chained threads into a plain knot. The last three or four stitches of a dart must be very close and parallel to the fold, resulting in a smooth shaping of the garment.

TORSO OR SHAPED DARTS

Torso and shaped darts are stronger and more flexible when stitched with a shallow zigzag. Stitch the points for a distance of one inch with straight stitching. Zigzag centre portion.

Use: All-purpose Throat Plate and Presser Foot
Central Needle Position
 $\frac{1}{2}$ to 1 Bight
25 Stitch for Zigzag and 12 Stitch for Straight
Stitching
Lever A

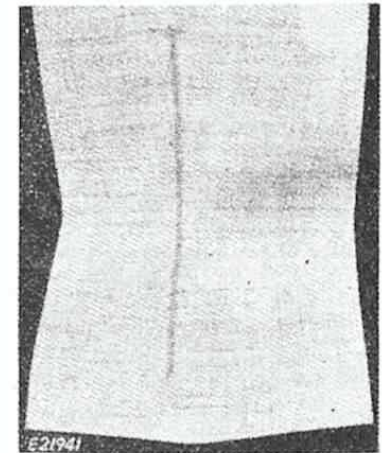

*Fig. 92
Torso or Shaped Darts*

CONTOUR DARTS IN INTERFACINGS

Contour darts in interfacings provide permanent shaping without bulk when cut, lapped and zigzag stitched along raw edges as in **Fig. 93**. The dart is often cut away, edges abutted and stayed with straight grain strip of muslin as in **Fig. 94**.

Use: All-purpose Throat Plate and Presser Foot
Central Needle Position
5 Bight
25 Stitch
Lever B



*Fig. 94. Contour Dart
with Abutted Edges*

ACCENTED DARTS

Darts add styling and interest when stitched with the fold to outside of garment. Thread ends at the point of the dart are eliminated when the single thread principle for stitching is employed. With thread leading through the throat plate from bobbin, thread needle from back to front. Tie bobbin and upper threads together and draw knot through threading points toward spool until a sufficient length of the thread leading from the bobbin has passed the thread guide nearest the spool to complete stitching the full length of the dart. Stitch from point of dart toward edge of garment section. Back stitch to reinforce at outer edge.

Further accent is given to such a dart when an arrowhead is placed at the point.

For Arrowhead, use:

All-purpose Throat Plate and Presser Foot

Central Needle Position

5 Bight

Almost 0 Stitch length

Arrowhead Disc No. 5

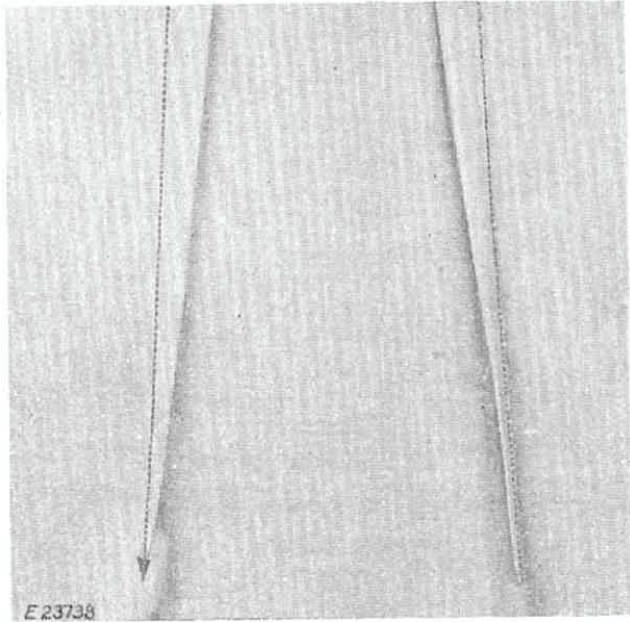

Fig. 95. Single Thread Darts

CONTROL OF FULLNESS

Contour and shaping are accomplished in garments of soft and sheer fabrics by contour shirring. Equip machine for straight stitching, and with a stitch length of 12 or less, according to the fabric, place five rows of parallel stitching $\frac{1}{8}$ inch apart, with the first row $\frac{1}{2}$ inch from the outside edge. Draw threads to inside of garment at one end only and tie. Form a pin tuck across the ends of stitching. Form shirring by pulling the threads on inside of garment at second end until shirring has been drawn together sufficiently so that garment sections match. Knot thread ends and finish with a pin tuck. Join sections of garment together. Three rows of stitching are visible when finished.

When controlling eased fullness in a sleeve cap, at the elbow of a long fitted sleeve, in the shaping of a circular hem or in joining yoke or fitting seams, two lines of control stitching are used and pin tucks are omitted.

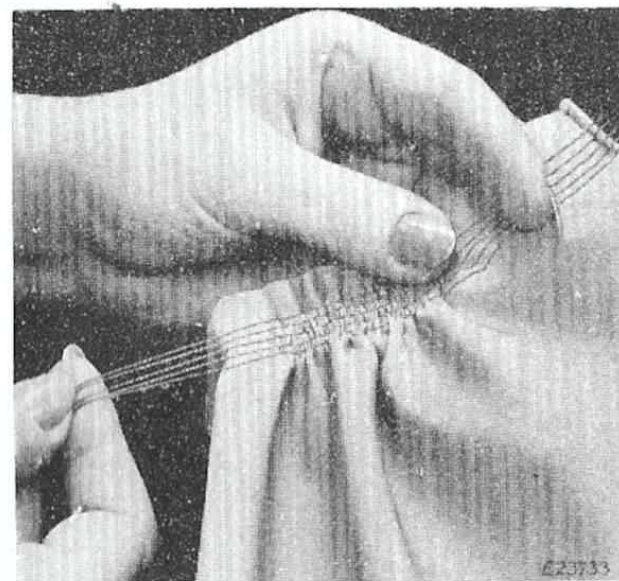

Fig. 96. Contour Shirring in Process

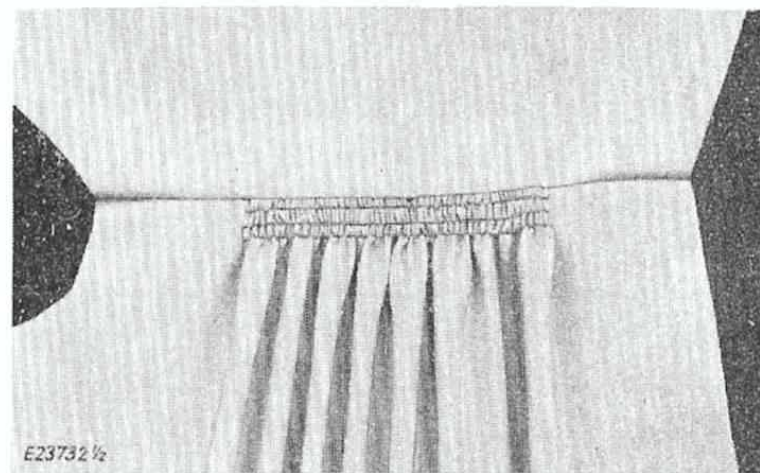

Fig. 97. Contour Shirring Completed

COUCHED ELASTIC SHIRRING

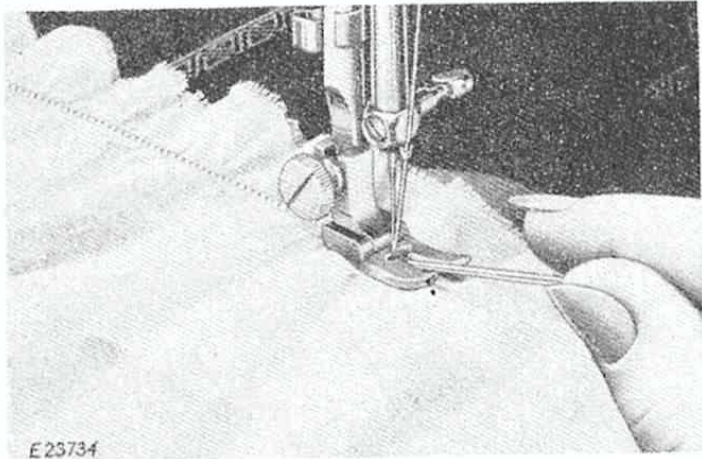

Fig. 98. Couched Elastic Shirring in Process

Elastic thread is often used to control fullness at the waistline or cuff. Zigzag stitch over one or two strands of elastic thread, drawing the elastic thread to give the tautness desired. Knot ends securely. This treatment provides a snug fit with elasticity. Either side may be used as right side, depending upon the effect desired.

Use: All-purpose Throat Plate and Presser Foot
 Central Needle Position
 1 Bight
 12 Stitch
 Lever A

ELASTIC SHIRRING

Elastic thread is wound on the bobbin without stretching, while regular sewing thread is used in the needle. The machine is regulated for straight stitching. Stitch parallel rows with a 10 stitch. The bobbin tension is regulated so that it is heavy enough to stretch the elastic thread when stitching, but light enough to avoid breaking or fraying. Thread ends are fastened securely by tying.

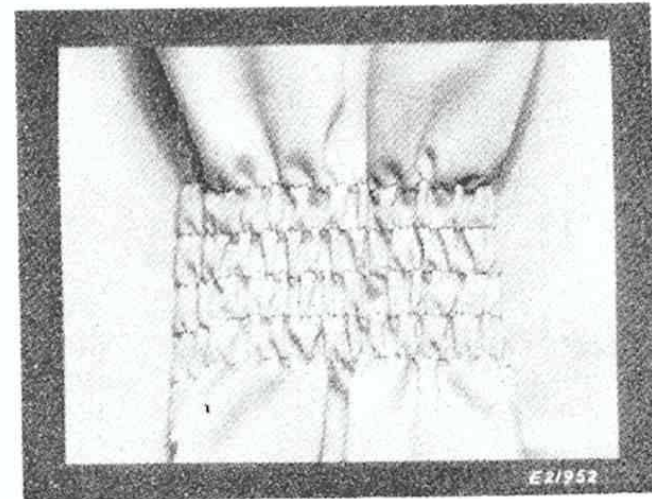

Fig. 99. Elastic Shirring Completed

ZIGZAG SEAMING

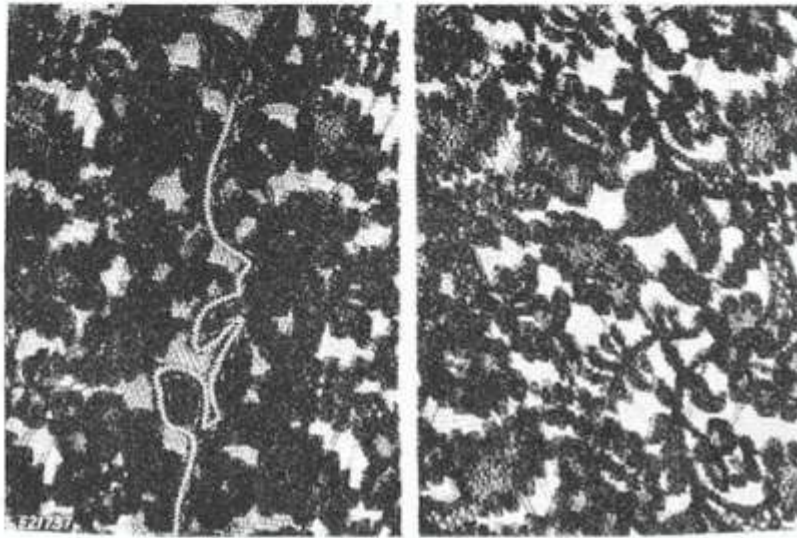

Fig. 100. Invisible Seam for All-Over Lace

Use: All-purpose Throat Plate and
Satin Stitch Foot 105251
Central Needle Position
1½ Bight
Above 25 Stitch
Lever A

After seams have been basted and fitted, mark outline of seam on both sections of garment with hand basting. Remove basting that joined seams and lay one section over other with seam lines matching and hand baste. Remove marking stitches. Satin Stitch Foot 105251 (see page 52) is used to follow outline of lace motif that runs through seam lap.

Cut away excess seam up to stitching on both right and wrong sides, using curved embroidery scissors.

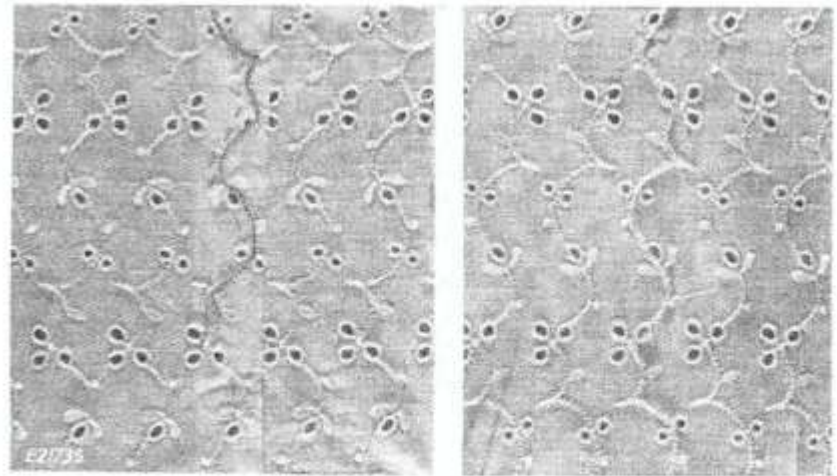

Fig. 101. Invisible Seam for All-Over Lace Embroidery

CORDING SEAM WITH SATIN STITCH FOOT 105251

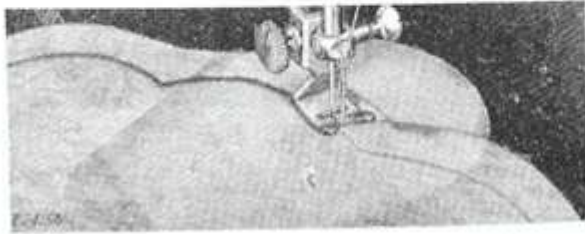

Fig. 102. Cording a Seam with Satin Stitch Foot 105251

Place a thread through the eye at the front of the foot and lead it underneath the foot. Cover thread with closely spaced zigzag stitches.

Use: All-purpose Throat Plate and Satin Stitch Foot 105251
Central Needle Position
2 Bight
Above 25 Stitch
Lever A

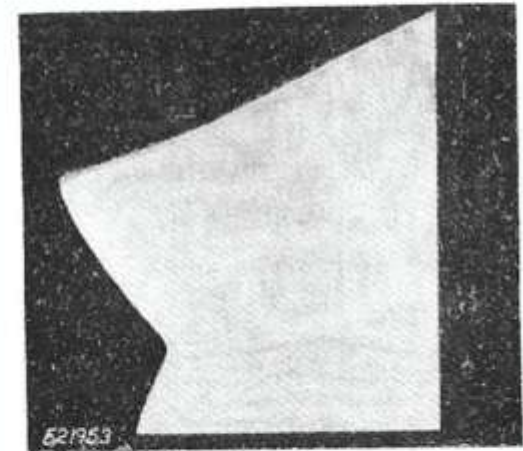

Fig. 103. Hairline Seam in Sheers

HAIRLINE SEAM IN SHEERS

For a dainty hairline seam in sheers that is also fray-proof, follow shaped seam line with a fine cording stitch, then cut surplus seam away close to line of stitching. This type of seam may be used either inside or outside.

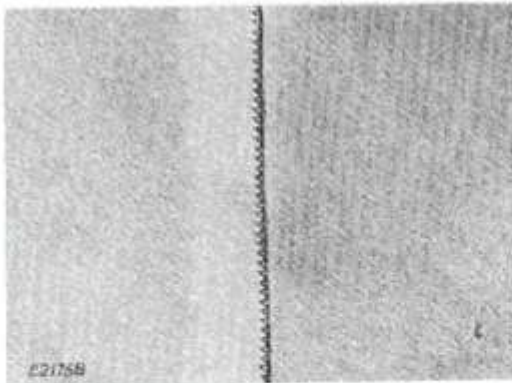

Fig. 104. Rip-proof Seam for Lingerie

RIP-PROOF SEAM FOR LINGERIE

For rip-proof seams in lingerie, first straight stitch fitted seam on wrong side and press both edges to one side.

Use: 0 Bight

15 Stitch for Straight Stitching

On right side of garment, top stitch with a fine zigzag stitch allowing needle to enter alternately channel of seam and seam thickness.

Use: All-purpose Throat Plate and All-purpose Presser Foot
Central Needle Position

2 Bight

25 Stitch

Lever A for Zigzag Stitching.

INVISIBLE SEAM FOR HORSEHAIR OR NET BANDINGS

Use: All-purpose Throat Plate and
All-purpose Presser Foot
Central Needle Position
1½ Bight
25 Stitch
Lever A

Guide braid or banding so that edges are abutted as they meet when passing under slot of foot.

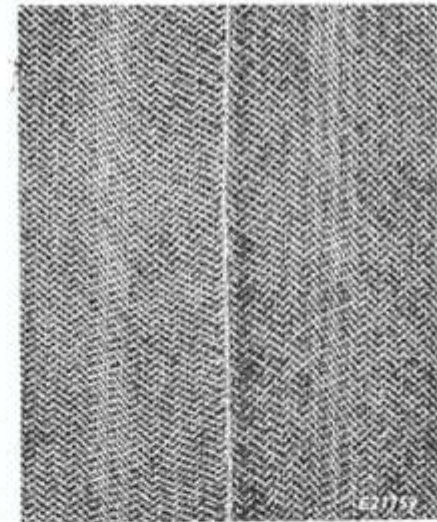

Fig. 105. Invisible Seam in Horsehair

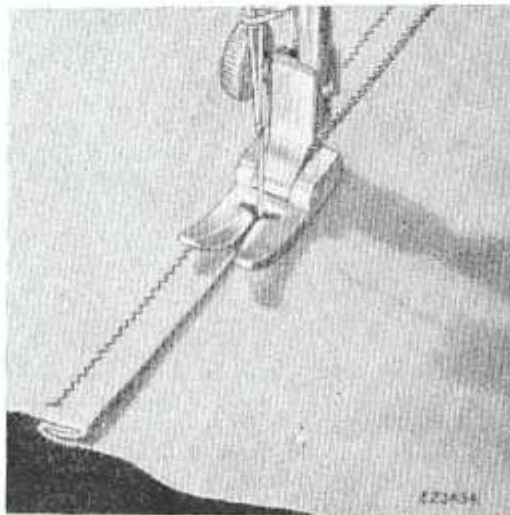

Fig. 106. Heavy Duty Reversible Seam

HEAVY DUTY REVERSIBLE SEAM

Use: All-purpose Throat Plate and Presser Foot
Central Needle Position
2 Bight
Above 12 Stitch
Lever A

For heavy duty, strain-proof seams, use double interlocked seam, zigzagged on both sides. Turn **under** raw edge of one section, and turn **up** raw edge of joining section. Interlock two raw edges and zigzag across one seam on right side and across other seam on wrong side, producing a double fell, doubly reinforced, with elasticity against strain when wearing.

STAYED SEAM FOR JERSEY OR CREPE

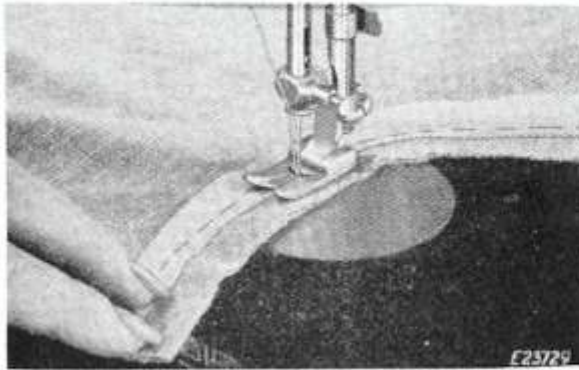

Fig. 107. Stayed Seam in Jersey

Seams in fabrics that stretch or bias seams in firm fabrics are often stayed with seam tape for durability. Position seam tape with edge exactly on seam line. If seam is curved, shape seam tape by steaming at the ironing board. Hand baste if necessary. Stitch with fine zigzag stitching. Press seam open, after clipping on curve.

Use: All-purpose Throat Plate and Presser Foot
 Central Needle Position
 $\frac{1}{2}$ to 1 Bight
 12 to 25 Stitch
 Lever A

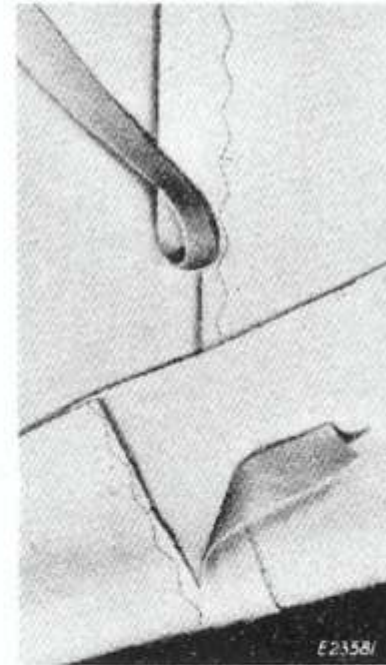

Fig. 108. Overlapped Seam for Interlining

OVERLAPPED SEAM FOR INTERLINING

The seams of an interlining are always overlapped to avoid excessive bulk in a garment. Care must be taken to use the full seam allowance. Stitch in the centre of the overlap with multiple stitch zigzag. Trim excessive width from seam edges. This seaming is durable, flexible and free of bulk.

Use: All-purpose Throat Plate and Presser Foot
 Central Needle Position
 5 Bight
 12 Stitch
 Lever B

SEAM FINISHES

TO OVERCAST OPEN SEAMS

Turn raw edge toward wrong side and, while stitching, let it pass over flanged toe of All-purpose Presser Foot and through slot. Guide material so that needle, when swinging to the right, pierces material exactly at edge.

Use: All-purpose Throat Plate and Presser Foot
 Central Needle Position
 2 Bight
 15 Stitch
 Lever A

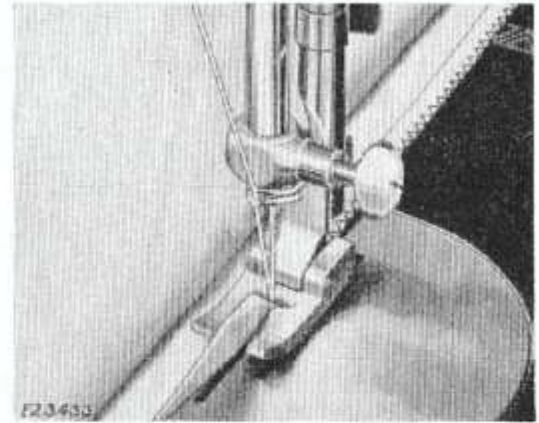

Fig. 109. Overcasting Open Seams

TO FINISH SEAMS IN TRICOT OR SHEERS

Step 1. Stitch seam with short straight stitching using Straight Stitching Throat Plate and Straight Stitching Presser Foot. Support material when stitching as described on **page 27**.

Step 2. Finish seam edges together with stitching controlled with the Blind Stitch Disc No. 3. Trim seam allowance close to stitching. This finish prevents fraying and provides a fine smooth edge.

Use: (for seam finish) All-purpose Throat Plate and Presser Foot
 Central Needle Position
 1 or 2 Bight
 25 Stitch
 Blind Stitch Disc No. 3

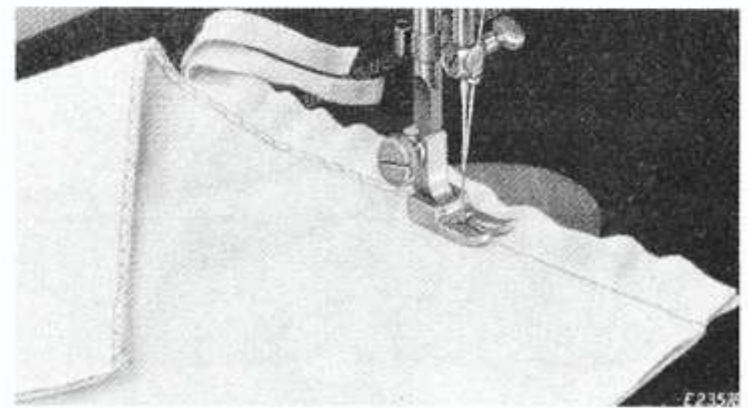

Fig. 110. Finishing Seam in Tricot

TO OVEREDGE SEAMS

Seam edges support the garment and should always carry a durable finish if fit is to be maintained after long wearing. The stitch made with the Blind Stitch Disc is especially durable and free of bulk when used as a seam finish.

When seam edges are pressed in the same direction, they are overedged together, and when pressed open, they are overedged separately.

Use: All-purpose Throat Plate and Presser Foot
 Central Needle Position
 4 or 5 Bight
 25 Stitch
 Blind Stitch Disc No. 3

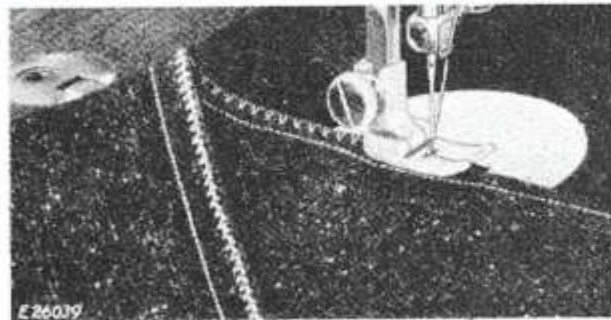

Fig. 111. Overedging Seam Edges Together

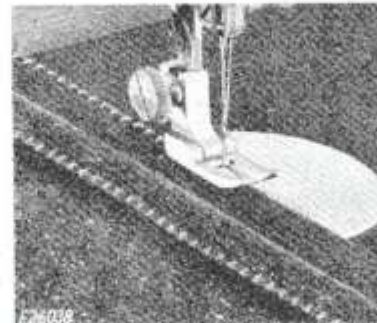

Fig. 112. Overedging Open Seams in Process

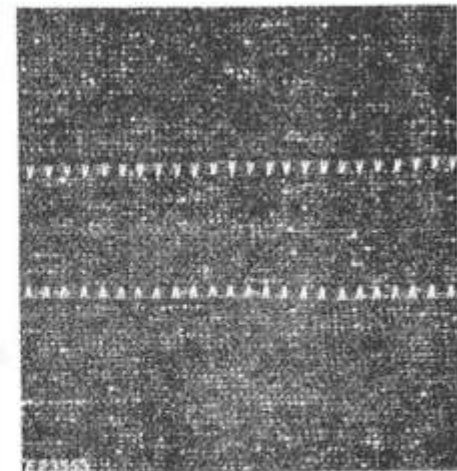

Fig. 113. Overedged Open Seams—Completed

TO MAKE BUTTONHOLES

Step 1. Marking the Material

Mark position and length of buttonholes with basting stitches (see **Fig. 114**) or marking chalk.

Step 2. Setting the Machine

Use: All-purpose Throat Plate and Buttonhole Foot 86616 (see **page 52**)

Left Needle Position (see **page 32**)

Above 25 Stitch (Stitch on a scrap to attain close setting of stitches.)

2 Bight for Side Stitches of Buttonhole (Use intermediate bight regulator screw.)

4 Bight for Barring Stitches (Use maximum bight stop screw **X**)

0 Bight for Fastening Stitches

Lever A

NOTE: Bight settings of $2\frac{1}{2}$ for Side Stitches and 5 for Barring Stitches make slightly heavier buttonholes.

Step 3. Guiding

With bight lever at 2, position the needle just left of central marking and stitch using point of buttonhole foot as a guide to keep stitches just left of central marking. (Note slot in buttonhole foot for drawing needle and bobbin threads through.)

When needle has reached end of marking, leave needle in fabric at the point nearest centre as shown by **A** in the illustrations.

Lift foot and using needle as a pivot, turn work around clockwise, as indicated by arrow **B**.



*Fig. 114. Step 1.
Marking Location of
Buttonholes with
Basting Stitches*

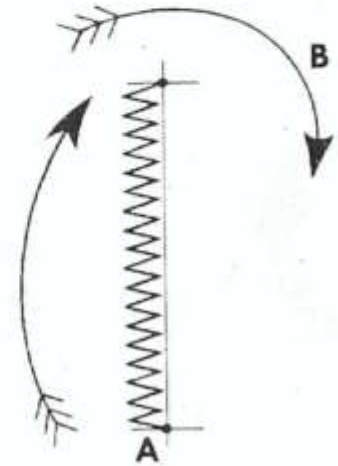

Fig. 115. Step 3.



Fig. 116
Step 4



Fig. 117
Step 5

Step 4. Pivoting

Lower foot and take one stitch, leaving needle in material at point C.

Step 5. Barring

With bight lever at 4 take six stitches, leaving needle in fabric at point D at left.



Fig. 118
Step 6

Step 6. Finishing Buttonhole Edge

Return bight lever to 2 and stitch second side of buttonhole, keeping point of buttonhole foot just left of central marking to provide sufficient cutting space.

Stop within six stitches of end, leaving needle in fabric at point E at outside marking. This point may be easily determined, while stitching, by observing last stitch in first row at lower edge of opening in buttonhole foot.

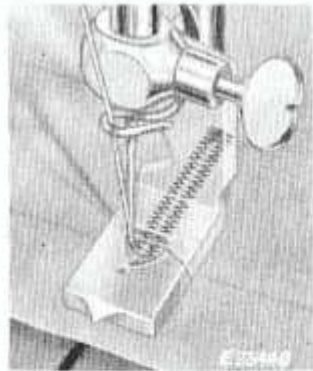

Fig. 119



Fig. 120
Step 7

Step 7. Finishing Final Bar and Fastening Stitch

With bight lever at 4 take six stitches to complete final bar. Set bight lever at 0 and take three fastening stitches at F. Cut buttonhole along line of centre marking.

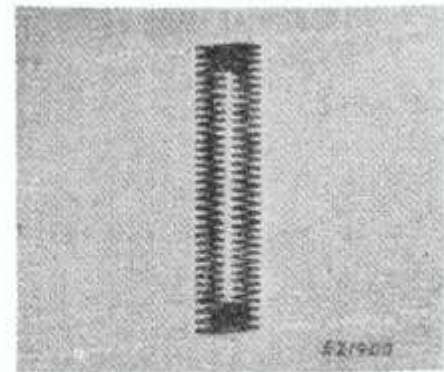
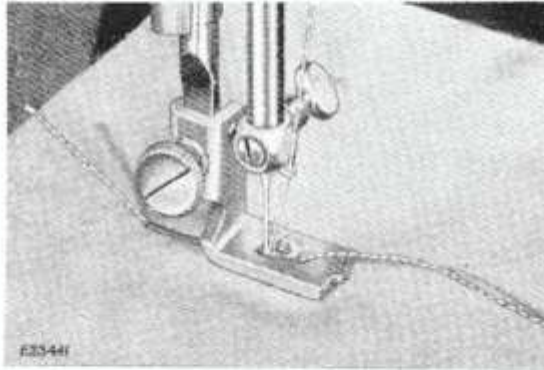

Fig. 121

Raised or Gimp Buttonholes



*Fig. 122. Making
Gimp Buttonholes*

Insert No. 8 perle cotton or buttonhole twist thread through eyelet in front of buttonhole foot, as shown in **Fig. 122**, and proceed as for regular buttonholes as instructed on **pages 67 and 68**.

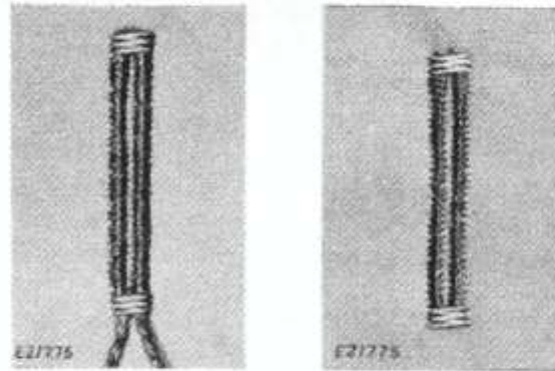

Fig. 123. Gimp Buttonholes

TO SEW ON BUTTONS

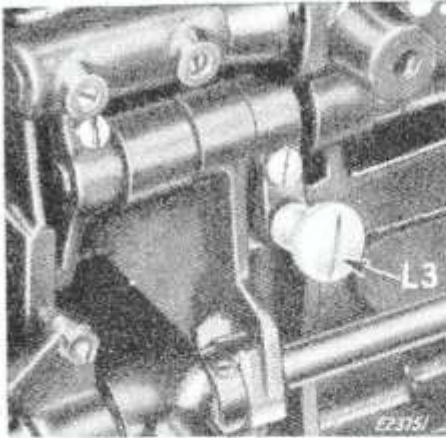

Fig. 124. To Lower the Feed

Lower the feed by turning machine back on its hinges and loosening screw **L3**, **Fig. 124**, turning it over to left (using a screwdriver, if necessary) as far as it will go. Bring machine forward into place and move stitch regulator lever **Q**, **Fig. 40**, page 23, to 0 position.

When regular sewing is resumed, tighten feed throw-out screw **L3**, turning it to right as far as it will go.

Use: All-purpose Throat Plate
 Button Sewing Foot 189648
 Left Needle Position
 Approximately 3 Bight
 0 Stitch
 Lever A

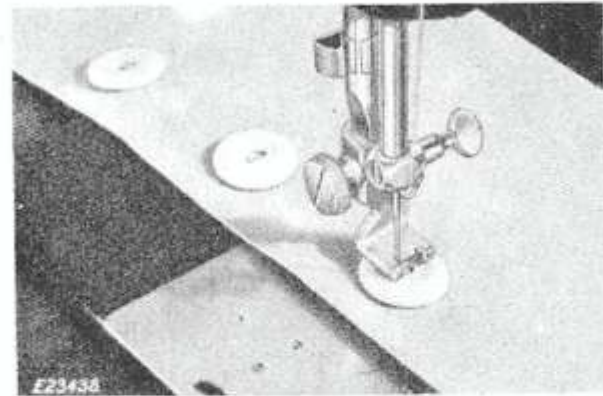

Fig. 125. Sewing on Buttons

With bight at 0, position button, drop needle through centre of left hole. Then lower button sewing foot. Turn hand wheel over toward you until needle rises. Set bight at approximately 3 or so that needle, on its right swing, enters centre of right hole. Then stitch. Needle should enter each hole six times. To fasten stitch, set bight at 0 and take 3 stitches in left hole of button.

TO SEW ON BUTTONS WITH THREAD SHANK

Follow steps outlined above and in addition, hold pin or needle between holes in button to deepen stitches and provide thread shank. A long thread shank results when the heavy end of sewing machine needle is used in place of a pin. Tighten needle thread tension if stitches appear to be loosely set.

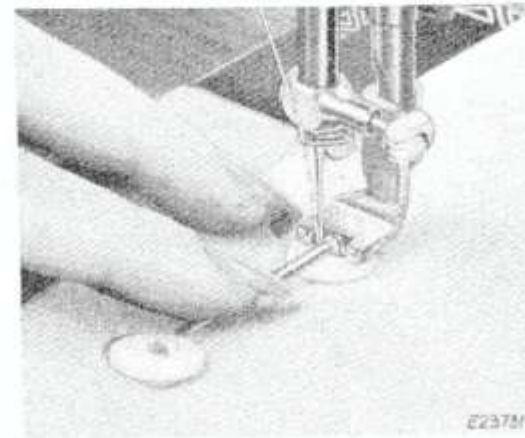

Fig. 126. Sewing Buttons with Thread Shank

TO SEW ON SNAPS AND HOOKS AND EYES

No Presser Foot is used for sewing on snaps. Instead, hold snap in place with tweezers, stiletto, or the point of embroidery scissors.

Lower the feed as instructed on page 70.

Use: All-purpose Throat Plate
 Left Needle Position
 0 Stitch setting
 2 Bight
 Lever A

Turn hand wheel over by hand to bring needle in position ready for its left swing. Centre needle in first hole and take 6 overedging stitches, leaving needle in hole at left position on last stitch. Change bight to 0 and take 3 fastening stitches. Carrying thread across snap, centre needle in next hole and change bight to 2. Take 6 overedging stitches, then returning bight to 0, take 3 fastening stitches. Continue this process with each hole.

The same procedure and settings are followed when sewing on hooks and eyes except that after taking 6 overedging stitches in first hole of hook, leave needle in centre of hole and turn work so that next 6 overedging stitches will carry across bar of hook, then proceeding to second hole, take 6 overedging stitches and

changing bight to 0, finish with 3 fastening stitches.

Follow same procedure for sewing on eye, taking 6 overedging stitches in first hole, 6 overedging stitches across to second hole, 6 overedging stitches to side of hole, and, changing bight to 0, finish with 3 fastening stitches.

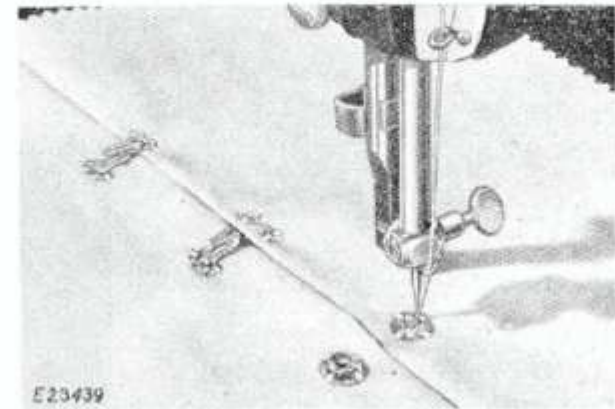
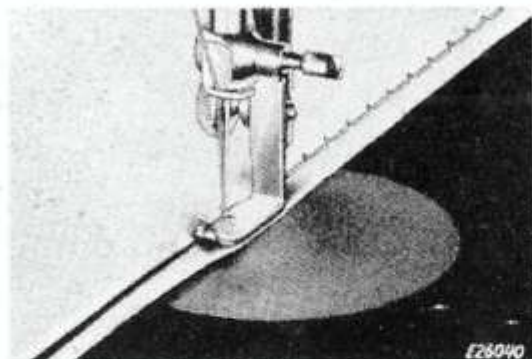

Fig. 127
Sewing on Snaps and Hooks and Eyes

BLIND STITCHED AND DECORATIVE HEMS

BLIND STITCHED HEMS WITH FOLDED EDGE



*Fig. 128.
Blind Stitched Hem in Process*

Blind Stitched hems are appropriate for curtains, draperies, table linens and fabric furnishings. Fold, press and baste hem, keeping basting stitches at least $\frac{1}{4}$ " from upper fold of hem.

Place hem against feed, turning the bulk of the work back in a soft fold. Position needle into folded edge of the hem near this soft fold. The Blind Stitch Disc produces four straight stitches separated by a single sideward stitch to the left. The sideward stitch should pierce the soft fold, resulting in a Blind Stitched hem. The bight is regulated at 2 or 3, depending on the weight and texture of the fabric.

The length of stitch regulates the distance between the Blind Stitches.

Use: All-purpose Throat Plate and
Cording Foot (right toe) 160846
Central to Left Needle Position
2 or 3 Bight
12 to 25 Stitch
Blind Stitch Disc No. 3

CAUTION: Left needle position must be used when bight 3 or 4 is used with Cording Foot (right toe).

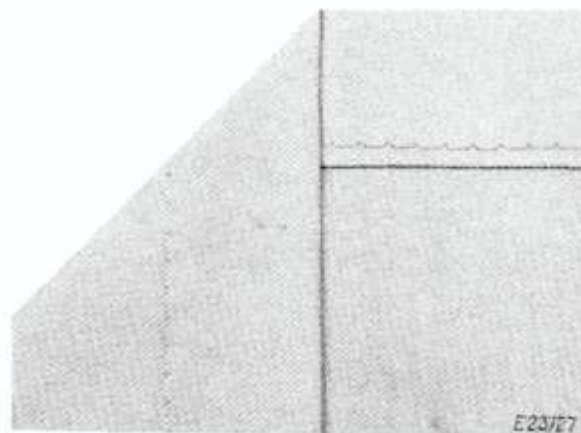

Fig. 129. Blind Stitched Hem Completed

SHADOW HEMS FOR TRICOT

Baste hem one-half inch from top edge. Position under All-purpose Presser Foot and stitch with $1\frac{1}{2}$ to 2 Bight, 25 Stitch and Blind Stitch Disc No. 3.

Trim raw edge near solid line of stitching. A small stitch will be visible at regularly spaced intervals on the right side of garment. To make this stitch less apparent, reduce width of bight.

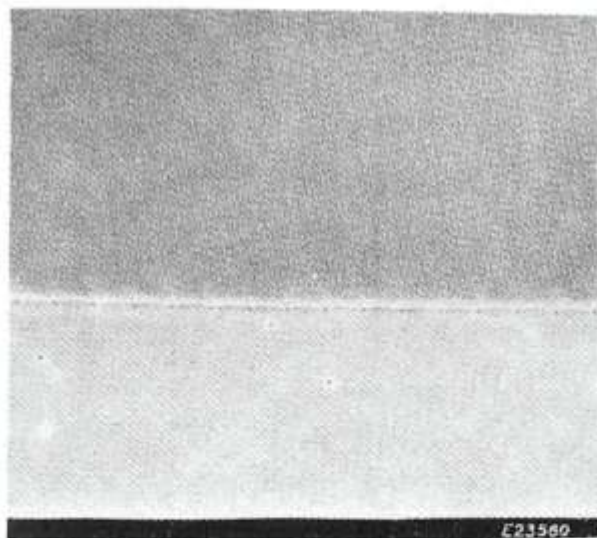

Fig. 131. Shadow Hem in Tricot Completed

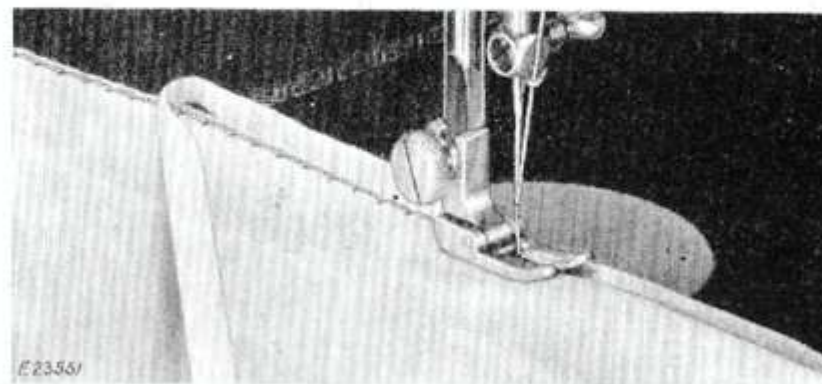

Fig. 130. Shadow Hem for Tricot in Process

Use: All-purpose Throat Plate and Presser Foot
 Central Needle Position
 $1\frac{1}{2}$ to 2 Bight
 25 Stitch
 Blind Stitch Disc No. 3

BLIND STITCHED HEM FINISHED WITH SEAM TAPE

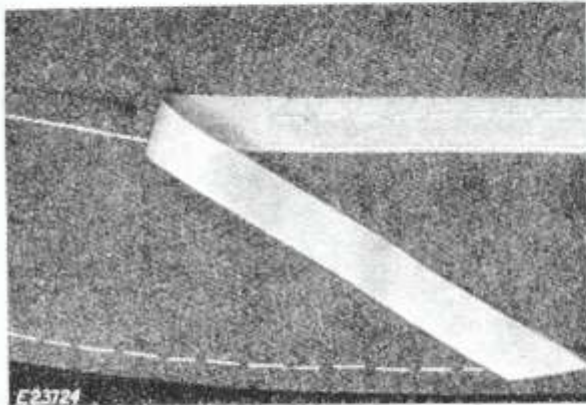

Fig. 132. Seam Tape Basted to Hem Edge Before Blind Stitching

Baste and stitch seam tape along this quarter inch control thread. Hand baste through centre of seam tape in preparation for Blind Stitching.

Position hem against feed with inside of garment rolled to the left to form a soft fold at basting line. Blind Stitch hem with the machine equipped as follows:

Use: All-purpose Throat Plate and Presser Foot
 Central to Left Needle Position
 1 to 3 Bight
 12 to 25 Stitch
 Blind Stitch Disc No. 3

Hems in skirts, dresses or coats have extra width at the top of the hem which must be considered. When the garment is flared or circular, there is more fullness in the hem than in straight cut styles. This fullness must be controlled before the hem is finished, if a smooth hem is to result.

After the length of the garment is marked, pin and baste with silk thread one-quarter inch from crease of hem. Press, to shape hem allowance, then measure and cut hem to desired width.

Control fullness by placing a line of straight stitching one-quarter inch from top edge of hem and draw bobbin thread, easing fullness and shaping top of hem to garment. Steam to shrink excess fullness.

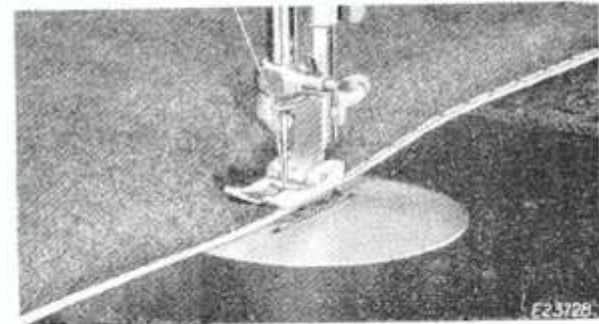

Fig. 133. Blind Stitching Hem Finished with Seam Tape

BLENDED CIRCULAR HEM

Circular hems in heavy coatings are smoothly finished, when the fullness is removed, by cutting away narrow wedges at regular intervals to allow the hem to conform exactly to the shape of the garment. The cut should not extend beyond one inch from the lower fold of the hem. Garments where this treatment is used are usually lined and the lining is carried to one inch from the edge.

Bring cut edges together and stitch with Multiple Stitch Zigzag Disc. Should the fabric be loosely woven, an underlay of thin lawn may be used as a stay on the underside.

Use: All-purpose Throat Plate and Presser Foot
 Central Needle Position
 5 Bight
 25 Stitch
 Lever B

The edge of the hem is finished by overedging with Blind Stitch Disc No. 3, 5 bight, and 25 stitch, as described on **page 66**.

Hand baste hem to garment three-eighths inch

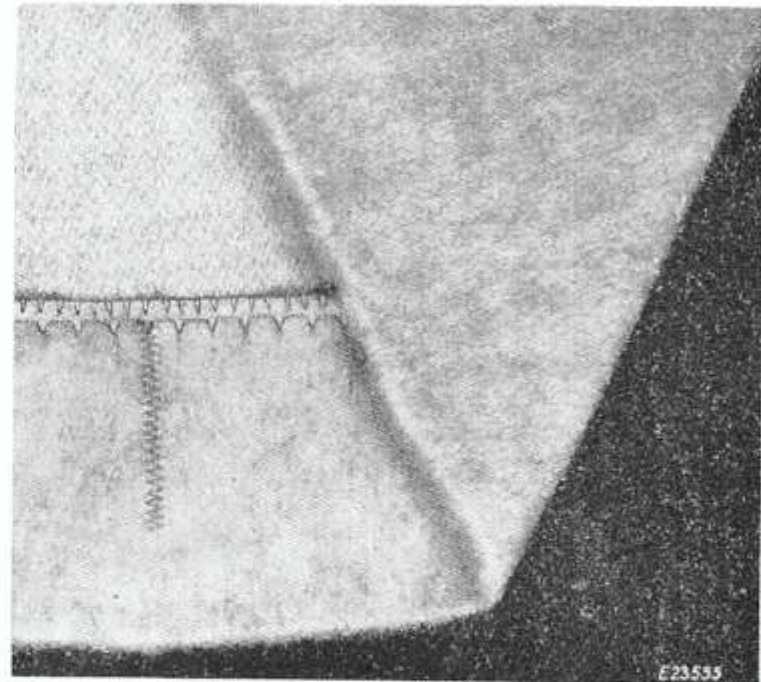

Fig. 134. Blended Circular Hem

from top edge of hem. Place hem against feed and turn garment to form a soft roll at basting line as in **Fig. 133, page 74**.

Use: All-purpose Throat Plate
 Cording Foot (right toe) 160846
 Needle Position, slightly left of Centre
 2 to 3 Bight
 Blind Stitch Disc No. 3

APPLIQUE SHADOW HEMS

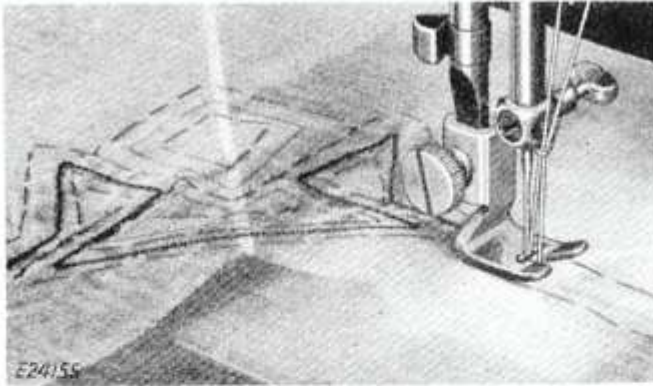

Fig. 135. Applique Shadow Hem in Process

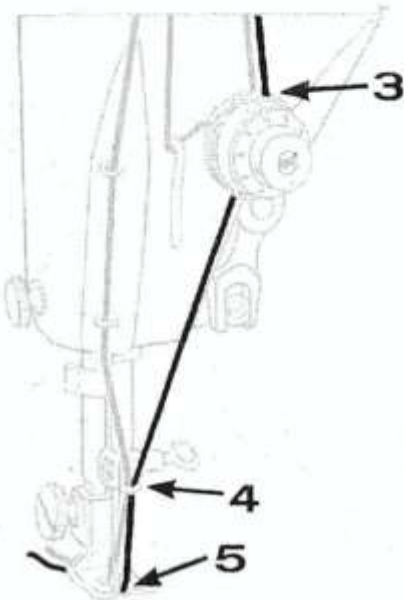

Fig. 136. Threading Satin Stitch Foot with Filler Cord

Shadow hems are lovely for table linens of crisp organdie or fine linen, and for dresses or aprons of sheer, crisp fabrics. Baste hem to full depth of design, corners mitred where necessary. Mark design on right side. Draw filler cord through opening in front of Satin Stitch Foot and follow design with fine, closely spaced zigzag stitching. When applique is complete, cut away surplus edge from wrong side close to stitching. See **Fig. 136** for threading of cord. Note that cord is

carried from the first thread guide down between centre and front tension discs, **but not into take-up spring**. Carry cord into needle clamp thread guide and then through the opening in the front of the Satin Stitch Foot.

Use: All-purpose Throat Plate
Satin Stitch Foot 105251
Central Needle Position
1 Bight
Almost 0 Stitch
Lever A

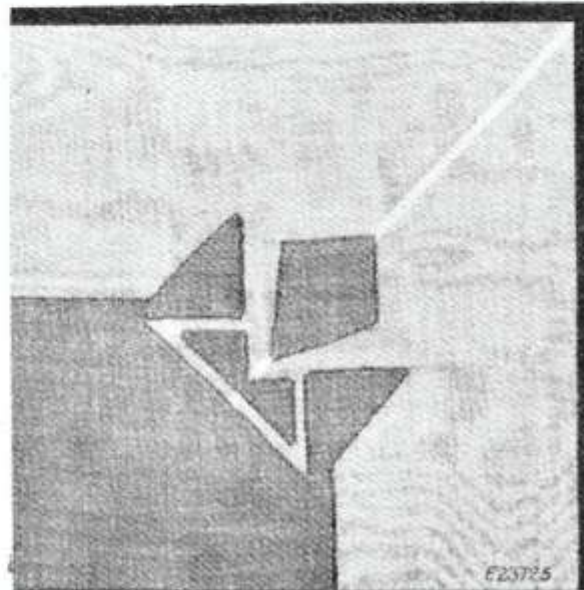
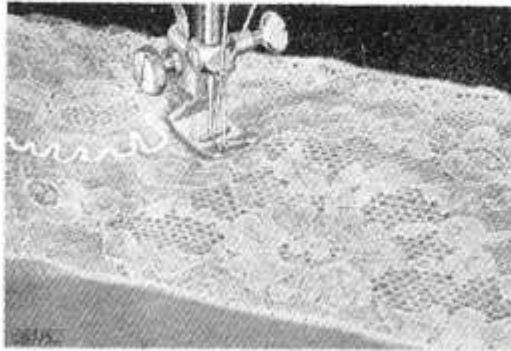

Fig. 137. Applique Shadow Hem Completed

EMBROIDERED LACE OR VIENNA WORK



*Fig. 138. Outlining Lace Motif with
Satin Stitch Foot 105251*

Use wide lace edging with a definite floral design, and baste into position, where desired, on right side of fabric. First follow upper lines of motif nearest edge, covering filler cord with tiny stitches along lines of motif, and continuing in an unbroken, continuous line. Then choose a section of the motif nearest edge and fully outline this separate motif, repeating at evenly spaced intervals for length of the lace. Finally, remove bastings, cut away surplus lace close to stitches of corded outlines and, from wrong side of garment cut away surplus satin along edge, close to lines of cording.

Embroidered Lace or Vienna Work is characteristic of high-priced lingerie. Yet it may be very quickly and easily accomplished with Satin Stitch Foot, using fine rayon or silk crochet thread as the filler cord to be covered. See **page 76** for threading of cord.

Use: All-purpose Throat Plate
Satin Stitch Foot 105251
Central Needle Position
1 Bight
Almost 0 Stitch
Lever A



Fig. 139. Lace Motif Embroidered Into Satin

SHELL STITCHED HEMS

Shell stitched hems provide a soft, ornamental finish for delicate fabrics, particularly when material is cut on the bias.

Lower shell hemmer over raw edge of fabric on wrong side of material. Take one stitch, raise shell hemmer. Draw the work back and cut threads. Holding both ends of attached needle thread, lead raw edge of fabric lightly into scroll of hemmer, drawing on threads to carry it through. On reaching slot of hemmer, lower the needle into hem, then lower hemmer and stitch.



Fig. 140. Leading Raw Edge Into Scroll of Shell Hemmer

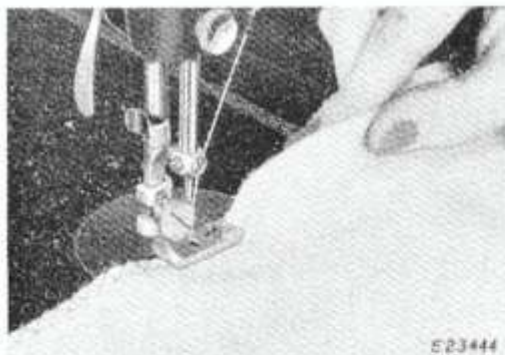

*Fig. 141
Shell Stitched Hem in Process*

Use:
All-purpose Throat Plate
Shell Hemmer 189653
Central Needle Position
5 Bight
8 Stitch
Lever A or B, Blind Stitch
Disc No. 3 or Shell Edge
Disc No. 7

Many variations of the soft scallop may be obtained by using different stitch settings and threads.

The automatic stitch designs lend further variation and interest to shell hems.

The shell hems illustrated are stitched with Blind Stitch Disc at 3 bight and 25 stitch (**Fig. 142**), and with Multiple Stitch Lever B at 5 bight and 25 stitch (**Fig. 143**).

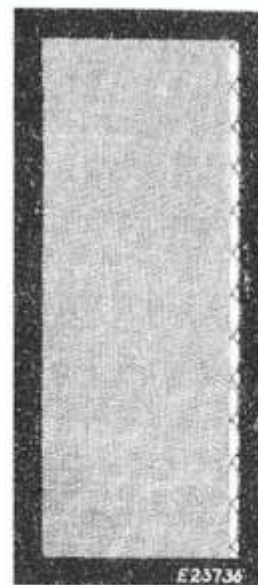

Fig. 142

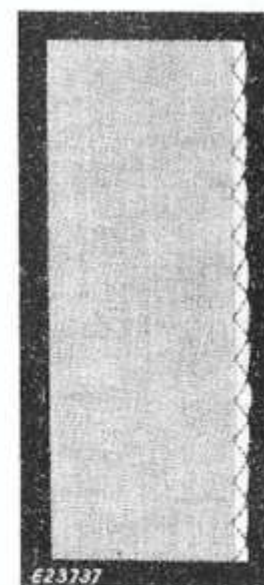

Fig. 143

Completed Shell Hems

SATIN STITCHED SCALLOPS

Satin stitched scallops provide a beautiful and durable finish for household linens as well as for wearing apparel.

Prepare the work for satin stitching by using a double thickness of fabric stayed with crinoline or organdie, or a single thickness backed with paper. Trace scallops in position, allowing a sufficient margin of fabric (about 2 inches), at right to grasp with right hand in guiding scallops. If, when cutting, sufficient length were not allowed, machine baste a piece of same fabric, or stay fabric just outside marked line of scallop.

Use a size 11 needle, 50 embroidery or silk thread, very light upper tension and medium light bobbin tension and **most important**, the Pressure on the **Presser Foot** must be set as light as possible so that the fabric can be moved from right to left while satin stitch is being made. The fabric remains straight at all times in line with the feed. Scallops are followed without turning by lightly moving the work, to right or left, so that the needle on its right swing follows the marking for the scallop.

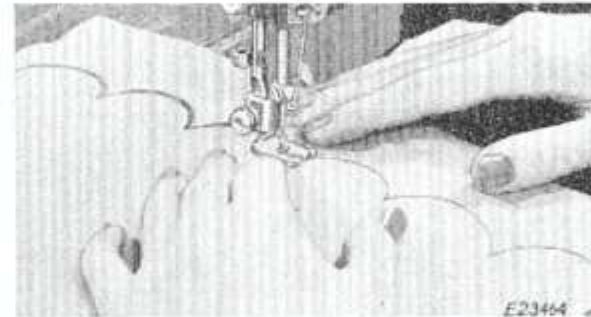

Fig. 144. *Satin Stitching Scallops*

This will maintain parallel stitches, evenly spaced, automatically producing the effect of a narrower stitch at the point between scallops and widening to full depth at the arc.

Use: All-purpose Throat Plate
 Satin Stitch Foot 105251
 Central Needle Position
 Almost 0 Stitch
 5 Bight
 Lever A
Light Pressure

TO CORD SCALLOPS

A finely corded edge is added to complete satin stitched scallops and to finish the edge. Lead heavy duty thread as a filler into eye of Satin Stitch Foot and carry it through and under foot. See **page 76** for threading the filler thread. Position needle close to edge of scallop, lower foot and stitch close to scallop, covering filler cord with closely spaced stitches, crowding against scallop all along the way.

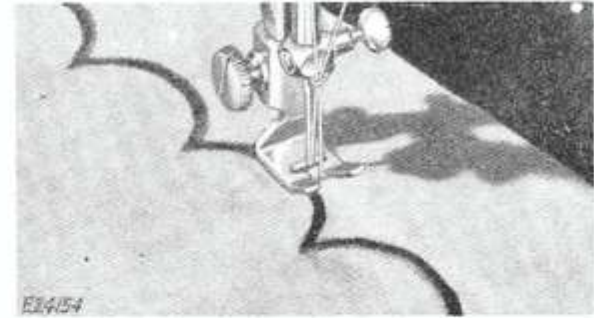

Fig. 145. Cording the Scallops

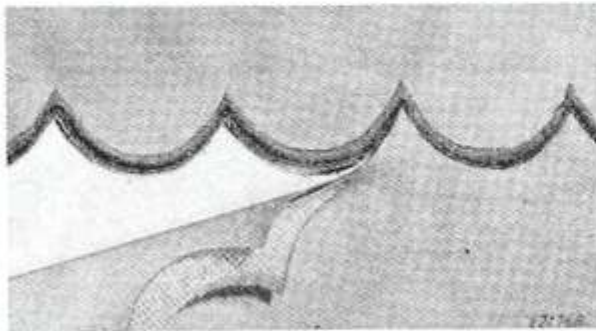

Fig. 146. Trimming Scalloped Edge

If scallops border a hem, cut away surplus of hem on wrong side close to inside of scallop. If scallops form an edge, cut away surplus border close to cording stitches on outside of scallop, at the same time cutting away foundation crinoline or organdie.

Use: All-purpose Throat Plate
 Satin Stitch Foot 105251
 Central Needle Position
 1 Bight
 Almost 0 Stitch
 Lever A
 Medium Pressure Adjustment

FRINGED EDGES

*Fig. 147. Following Drawn Thread
with All-purpose Presser Foot*

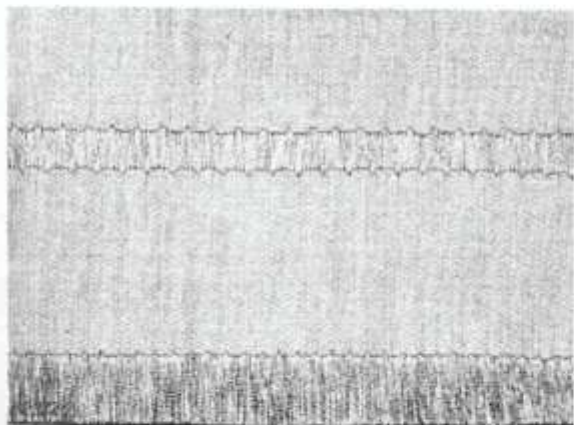

*Fig. 149. Blind Stitch Used for
Fringed Edge*

Use: All-purpose Throat Plate
and All-purpose
Presser Foot
Right or Left Needle
Position
2 Bight
12 to 25 Stitch
Lever A
Blind Stitch Disc No. 3

Draw a thread marking
depth of fringe. Stitch
along this line. Beginning
at raw edge, draw out
threads up to stitched line.

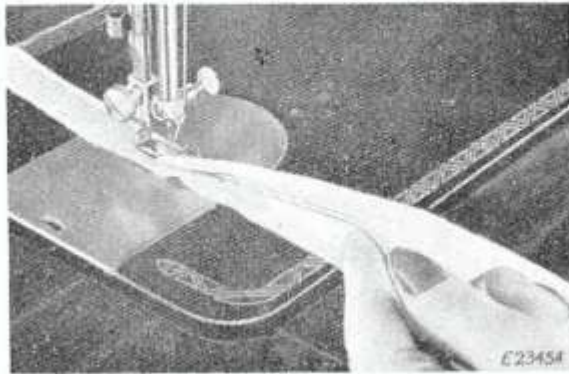

Fig. 148. Wide Hemstitching

Wide hemstitching is done in same manner as fringed edges, except that threads are drawn to mark width of hemstitching. When using Blind Stitch Disc, stitch to complete one side of hemstitching. Turn fabric and stitch second side, matching stitches. Then draw remaining centre threads between rows of stitching.

Lever A or Blind Stitch Disc No. 3 are equally effective to use for fringed edges and wide hemstitching.

CORDED EDGES WITH FABRIC COVERED CORD



*Fig. 150 . Covering Cord with Cording Foot
(Left Toe)*

Use: All-purpose Throat Plate, or
Straight Stitching Throat Plate
Central Needle Position
0 Bight
Cording Foot (Left Toe) 160845
Cording Foot (Right Toe) 160846

To cover Cord cut bias strip twice the width of the seam allowance plus cord. Fold bias over cord, raw edges even, and position needle close to cord, but not into it, and lower Cording Foot (Left Toe). Stitch, guiding the edge of the foot next to the cord, but do not crowd the foot against it.

Machine Baste Cord to right side of garment using Cording Foot (Right Toe).

Apply facing and position under needle, with facing next to feed and garment next to foot, so that basting stitch will be in view. Stitch, this time crowding the foot against the cording and making stitches between the basting and the cording.

Before turning work, blend seams by cutting away seam allowances, the bias to $\frac{1}{8}$ " and the garment and facing to $\frac{1}{4}$ ".

Corded seams and edges lend smartness to tailored garments. Cushion covers and slip covers are usually finished with corded seams. The cording feet are essential for making corded seams and edges and have many applications in addition to stitching zippers and hems.

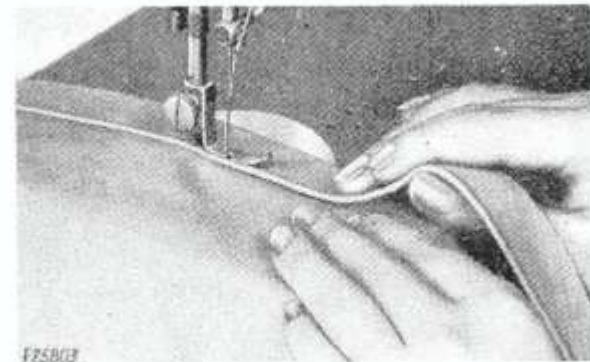

*Fig. 151 . Machine Basting
Covered Cord to Garment*

SCALLOPED EDGES

Fig. 152. Scalloped Edge in Process

Use: All-purpose Throat Plate and
All-purpose Presser Foot
Central Needle Position
5 Bight
12 to 25 Stitch, as desired
Lever C

Stitch in the same way as when making a straight seam. The garment section will pass straight under the presser foot while the needle follows a scallop pattern. Trim seam allowance to less than $\frac{1}{8}$ " and clip into each point between scallops.

Blend this narrow seam by clipping small wedges at regular intervals. When the scallop is turned, the seamed scallop edge will have a smooth even contour.

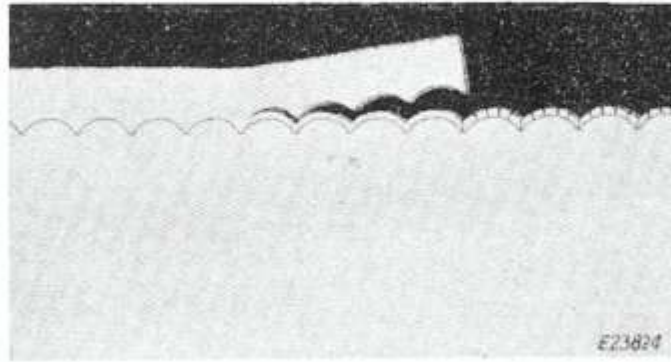
SCALLOPING

When the Scallop Disc is in use, the needle moves to form a scallop while the fabric moves in a straight line under the presser foot. The depth of the scallop is controlled by the bight setting. A 5 bight produces a scallop approximately $\frac{3}{16}$ " deep and each bight setting of less than 5 produces a correspondingly narrower scallop.

The length of scallop varies with the stitch length. A 12 stitch and a 5 bight produce a scallop approximately $1\frac{1}{4}$ " in length, a 25 stitch and 5 bight give approximately a $\frac{3}{4}$ " scallop, while a stitch length above 25 produces a scallop of $\frac{1}{2}$ " in length or less depending upon the stitch.

A single straight stitch separates each scallop providing space for cutting when the seam edges are trimmed and turned to form the finished, faced scallop edge.

Scalloped edges are used extensively on blouses, dresses and on children's wear.

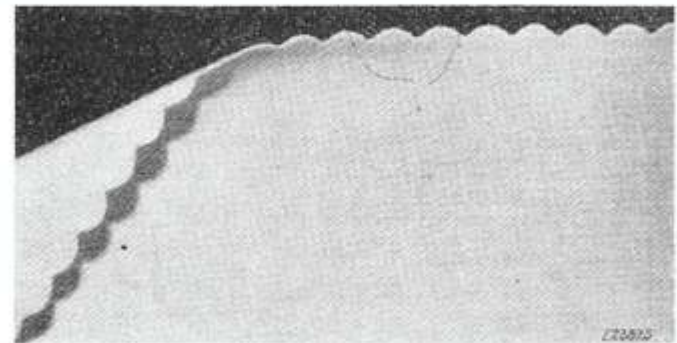
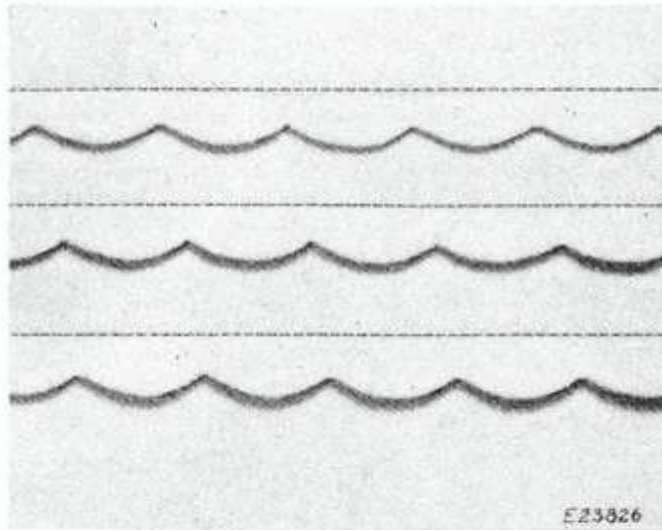

Fig. 153. Scalloped Edge Completed

SCALLOPED TUCKS*Fig. 154. Scalloped Tucks*

Scalloped Tucks are formed in the same manner as the scalloped edge. In planning, added width of at least $\frac{1}{4}$ " must be allowed for seaming and trimming the scallop. Form scallops first, then turn and stitch tuck with straight line of stitching spaced as desired.

SHADOW SCALLOPING WITH TWIN NEEDLES

Sheer fabrics are well suited to shadow scalloping. Limit bight to 3 and set machine at central needle position. Insert twin needles as described on **page 43** and replace presser foot with satin stitch foot. Loosen needle thread tension slightly and set desired stitch length between 12 and 25. If several rows are used, start each row with the stitch pattern beginning at the same point. Should fabric be soft, use an underlay of fine organdie and trim away closely at line of stitching.

Shadow scalloping is attractive by itself or in combination with scalloped tucks on blouses, dresses and children's clothes.

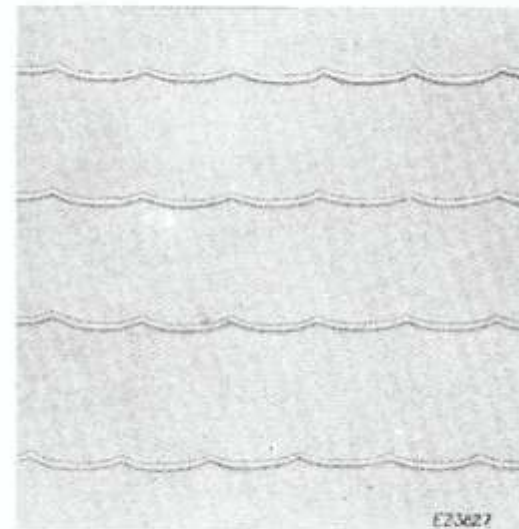
*Fig. 155. Shadow Scalloping*

MONOGRAMS

Attractive variation is given simple monograms when one or more automatic stitch patterns are introduced. Select a monogram from the many transfer designs available or sketch one to suit your purpose.

Back fabric with tarleton, crisp lawn or organdie. Trace or stamp design on right side of material. Cut away backing when stitching has been completed.

The monograms on this page are suggestive of the wide range and many variations which can be achieved.



Fig. 156

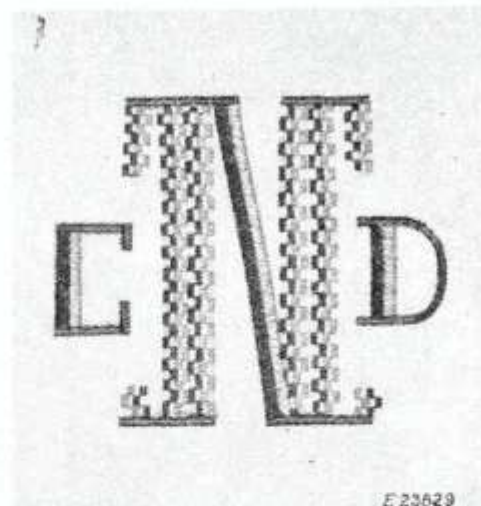

Fig. 157

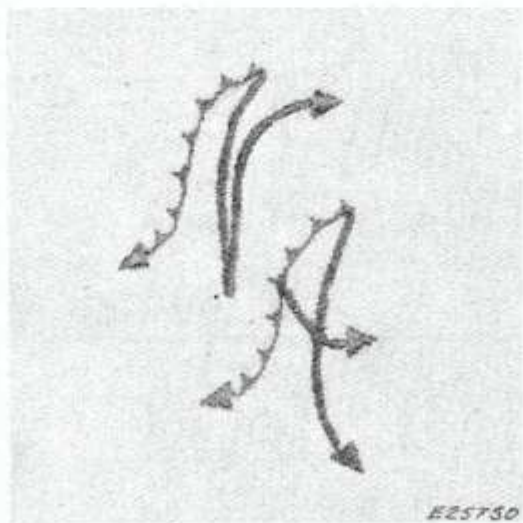

Fig. 158

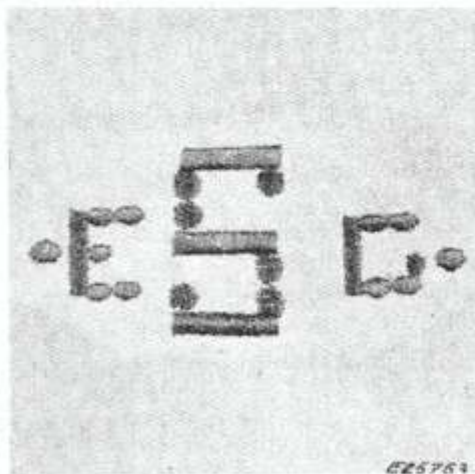

Fig. 159

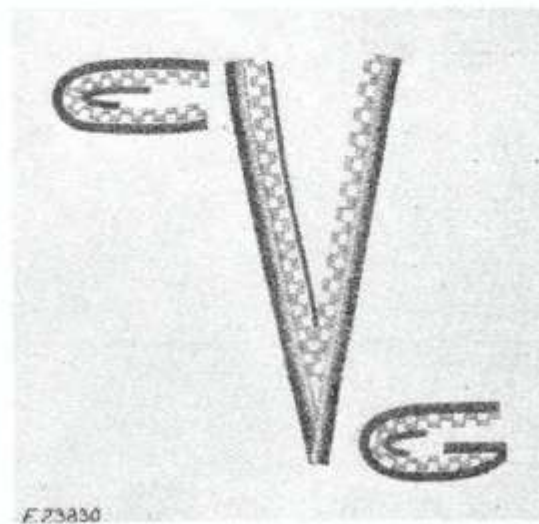

Fig. 160



Fig. 161. Script Stitching with Hoops

the needle and follow the outline traced. Should thread breakage occur, check setting of needle, decrease tension and use crisp lawn or organdie as an underlay.

SHADOW MONOGRAM

Shadow monograms have a dimensional appeal accomplished with threads of different colours or shades and with twin needles. Proceed as for script stitch. **Limit bight to 3 or less** and use a needle thread tension slightly lighter than for script stitch. Stitch more slowly when crossing one line of stitching over another. Where lines cross, stitch the first line less dense and allow the second line of stitching to be more prominent. Move embroidery hoops in forming letters so that most of the motion is away from you. Move hoops with the stroke of the needle, taking care not to bend or deflect needles. Shadow monograms are equally appropriate for linens and wearing apparel.

SCRIPT STITCH

Do not lower the feed.

Use: Embroidery Plate No. 189632 (Page 52) 3 Bight
 No Presser Foot 0 Stitch
 Central Needle Position Lever A

Script stitch is most effective for marking baby blankets, children's wear, household linens, lingerie or accessories.

After tracing or marking lettering on right side of fabric, place in embroidery hoops large enough to encompass word or initials to be worked, with right side inside hoops. Place work under needle, lower the presser bar, position



Fig. 162 Shadow Monogram

DESIGNS AND MOTIFS

A touch of stitching, smartly placed, is subtle and fashion wise. The motifs illustrated on these pages are examples of stitching accomplished with a combination of several discs from simple original designs. When used on a collar point, tie, tab or pocket they add smartness and individuality. For **Fig. 163**

Use: All-purpose Throat Plate
Satin Stitch Foot 105251
Central Needle Position
3 Bight for lines and
5 Bight for Arrowheads
Almost 0 Stitch
Lever A
Arrowhead Disc No. 5

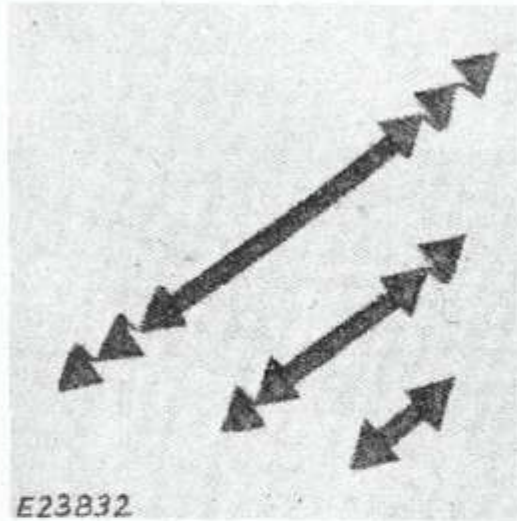

Fig. 163

Stitch lines first, add arrowheads. Stitch on a scrap of fabric until the arrowhead is completed and the needle is ready to take the last centrally located stitch at the point. Position needle in the centre of the bar of stitching, lower foot and stitch slowly, completing the number of arrowheads desired.

For **Fig. 164**, equip machine as indicated above and in addition to the Arrowhead and Zigzag, use the Multiple Stitch Zigzag at a **5 bight** and **almost 0 stitch** length.

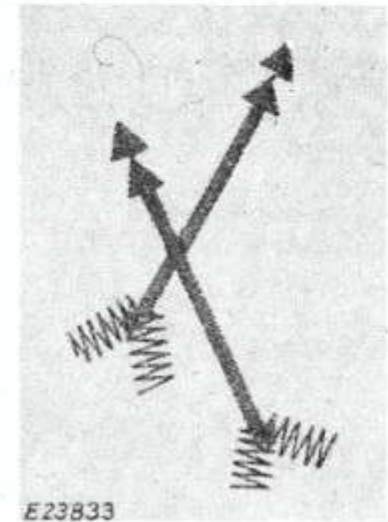

Fig. 164

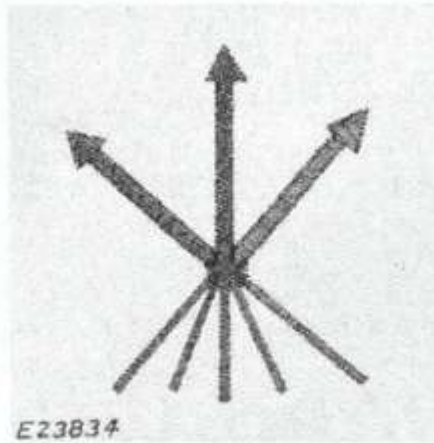

Fig. 165

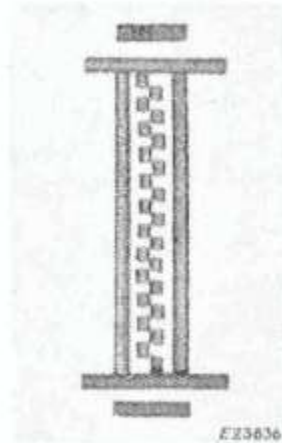

Fig. 166

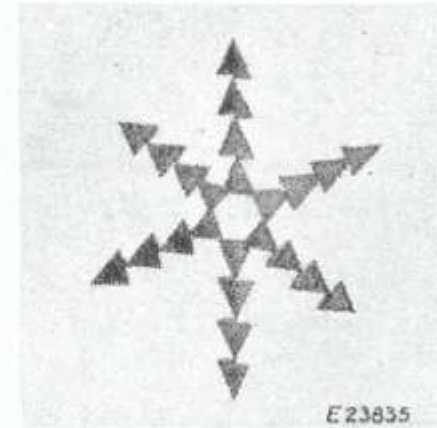

Fig. 167

The Zigzag and Arrowhead stitches are used to form the design in **Fig. 165**.

Classic designs, such as the one in **Fig. 166**, are smart when used singly or in groups. The Zigzag and Domino stitches are used, following simple, straight lines.

The star of arrowheads in **Fig. 167** is formed with the Arrowhead stitch by stitching from the centre outwardly.

The leaf motif in **Fig. 168** is attractive for creating an embroidered fabric to complement a plain fabric. The Banner Stitch (Disc 10) is used at a **5 bight** for the outer edges and the Zigzag (Lever A) at a **1 and 2 bight** for centre lines.

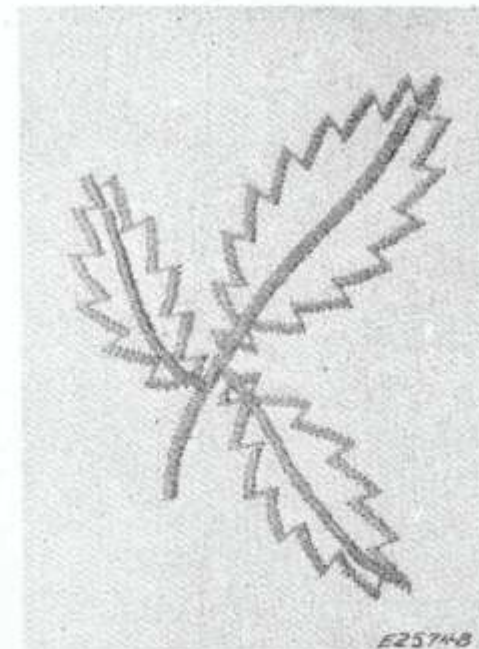

Fig. 168

BORDER DESIGNS

Unlimited variation and expression are possible in border designs when several stitch patterns are used in combination. The width and density of the border can be varied according to the application. In addition to the suitability of such stitching for linens, draperies and apparel as border designs, it is effective on plain fabrics to simulate striped or plaid effects. A popular application of these designs is for pockets, yokes, cuffs and applied bands. Three Discs are used in forming the border design in **Fig. 169**. After stitching the rows of

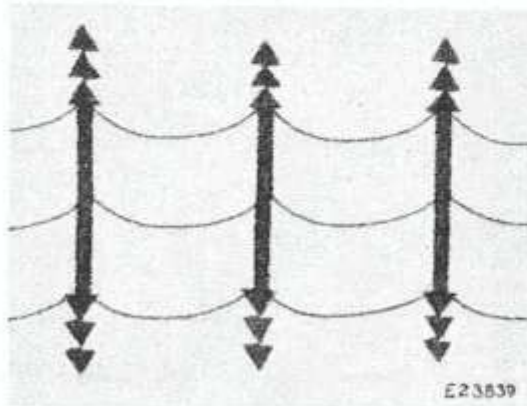

Fig. 169

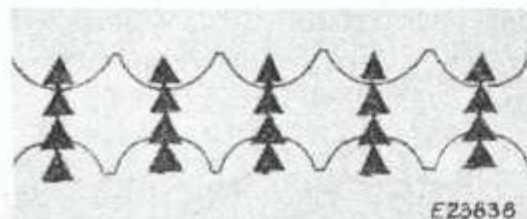

Fig. 170

scalloping with a **5 bight**, and **above 12 stitch length**, satin stitched bars are made with Zigzag Disc, **3 or 4 bight** and **almost 0 stitch** across points between scallops. Arrowheads accent each solid bar of stitching at **5 bight** and **almost 0 stitch**.

The Scallop and Arrowhead stitches are used to form the attractive design in **Fig. 170**. Two lines of scallop stitching—**bight 5**, and **stitch above 25**—are crossed by groups of arrowhead stitching—**bight 5**, **stitch almost 0**.

Lace insertion and edging are cleverly applied with any of the many stitch designs. **Fig. 171** illustrates the use of the Solid Scallop Disc 8 at **5 bight** and **almost 0 stitch length**.

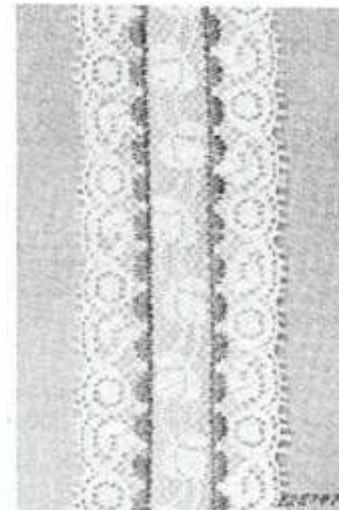

Fig. 171

Border designs such as the one illustrated in **Fig. 172** are made by using a combination of stitches. The centre line is Zigzag Satin Stitch with Zigzag Point on each side. The outer lines are made of the Ball Stitch, open Zigzag and Solid Scallop. Innumerable combinations are possible with the 319K Machine.

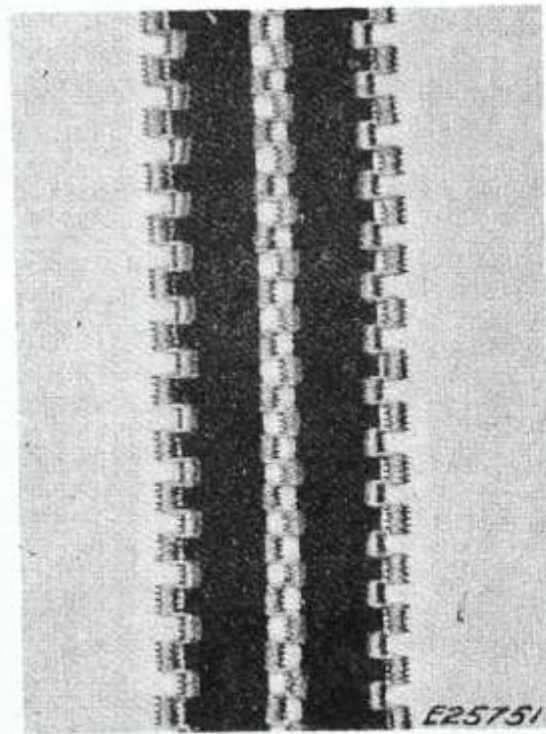

Fig. 173

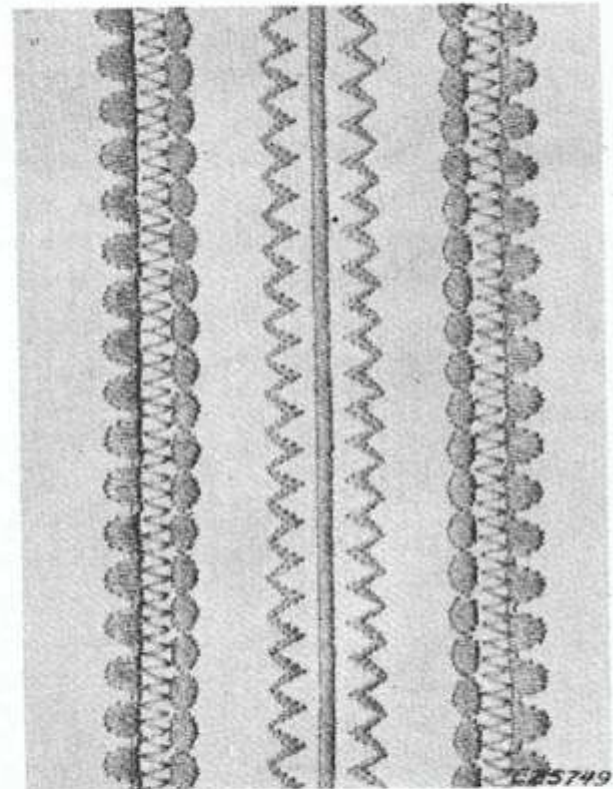

Fig. 172

Velvet ribbon complements the Domino Stitch for a bold accent on dresses or leisure costumes. See **Fig. 173**. The velvet ribbon is carefully machine basted in place before the Domino Stitch is added.

BUTTONHOLE POCKETS

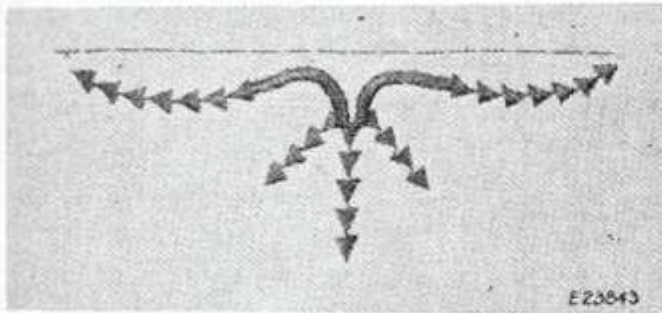

Fig. 174. Step 1 of Pocket in Process

The pocket design illustrated in **Fig. 174** is stitched using the Zigzag Stitch while the machine is set for a **3 bight** and **almost 0 stitch**. The Arrowhead Stitch is used with the machine regulated for a **5 bight** and an **almost 0 stitch**. Trim backing away along outside of stitching when design is completed.

Locate pocket section on underside of garment and from the right side, using Buttonhole Foot 86616, a **2½ bight**, and an **almost 0 stitch**. Proceed as for making buttonholes, eliminating the reinforcement bars of stitching at each end. Cut between bars of stitching to form pocket opening as was done in **Fig. 175**.

Buttonhole pockets accented with stitched designs are effectively made on the SINGER Automatic Machine. Appropriate for dresses of tailored and classic style as well as for blouses, shirts and sportswear, these pockets are simple to make and are sturdy and durable. Mark position of pocket opening with a basting line and the design for stitching with a fine chalk line. A backing of lawn, organdie or muslin provides the body and firmness desirable when satin stitching is used.



Fig. 175. Step 2 of Pocket in Process

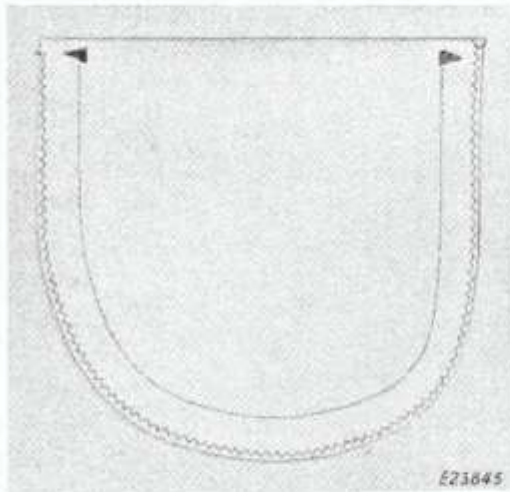

Fig. 176. Underside of Completed Pocket

Bring pocket sections together and seam with straight stitching. Finish seam with Zigzag stitching to stay edges and prevent fraying. **Fig. 176** shows the underside of the completed pocket. Place Arrowheads at each end of the bars of stitching from right side of garment to reinforce ends of opening and to complete pocket as shown in **Fig. 177**.

Simple, graceful designs are best for decorative pockets. The styling of the garment will often suggest a line that can be repeated to form the basis of the pocket design. The machine itself will suggest variations in design that are original and interesting, such as the design shown in **Fig. 178**.

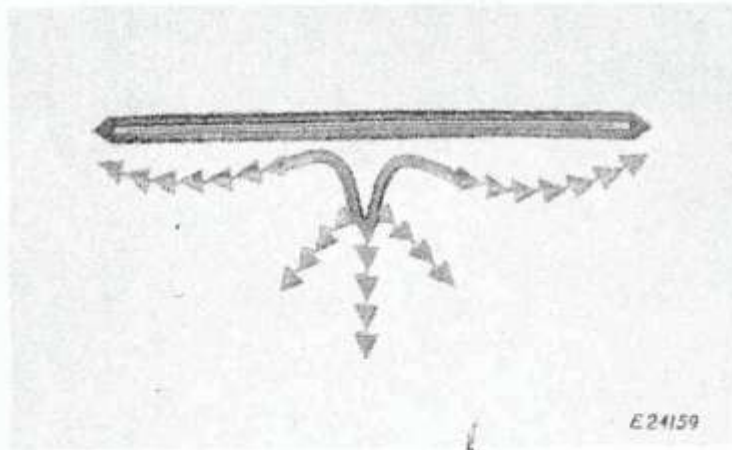

Fig. 177. Right Side of Completed Pocket

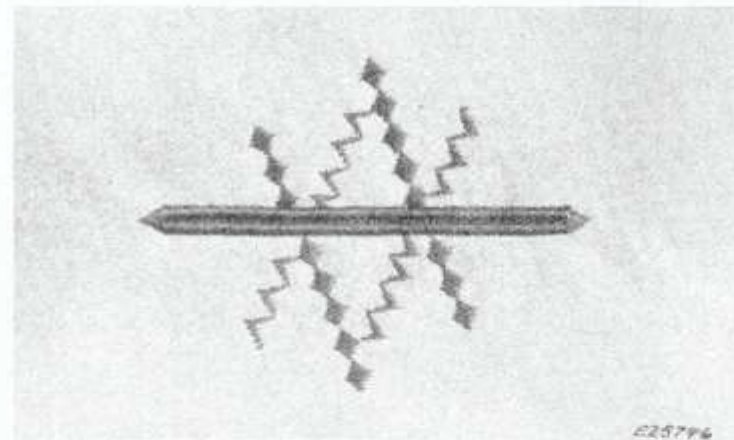

Fig. 178. Decorative Pocket

BRAIDING WITH GIMP

Use: All-purpose Throat Plate
 Satin Stitch Foot 105251
 Needle Position slightly **right** of centre
 1 Bight
 12 to 25 Stitch
 Blind Stitch Disc No. 3

Gimp yarns, available in various sizes in needlework departments, afford an interesting treatment when used as braid. The plain zigzag or the blind stitch can be used, depending on the effect preferred.

Trace design on right side of fabric. Pass gimp through eye of the Satin Stitch Foot. The needle position and bight may be varied slightly from the above settings to accommodate any one of several sizes of gimp yarn.

When design is completed draw ends of gimp to the back of fabric through an opening in the weave punctured with a stiletto or coarse needle. Fasten gimp with hand stitching against the underside of the design for about an inch.

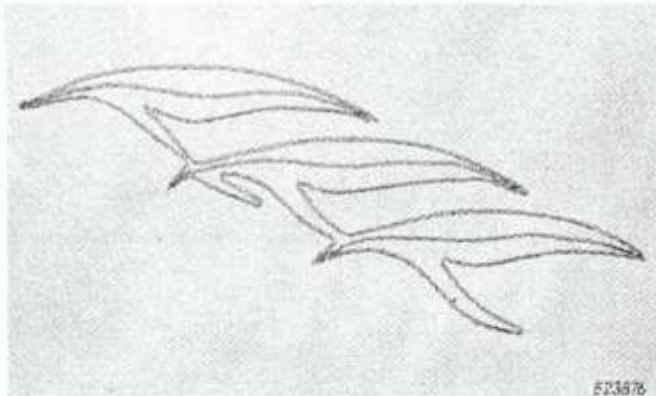

Fig. 179. Gimp Yarn Applied as Braid with Blind Stitch

Braiding with rayon or metallic gimp is attractive on synthetics, woolens, felt or heavy silk.

NOVELTY BRAIDING

Bold, interesting effects result from the use of automatic stitch patterns in combination with novelty yarns. Straw yarn is cleverly applied with the domino stitch. Two strands are held under the Satin Stitch Foot. Long yarn ends are allowed at intervals in the design to form tufts. Trim and brush yarn to give the effect illustrated.

Use: All-purpose Throat Plate
 Satin Stitch Foot 105251
 5 Bight
 Above 25 Stitch
 Domino Disc No. 6

Novelty effects with yarns are attractive for fabric furnishings and play clothes. Many clever trimmings are possible by varying the yarn and design as well as the stitch pattern.

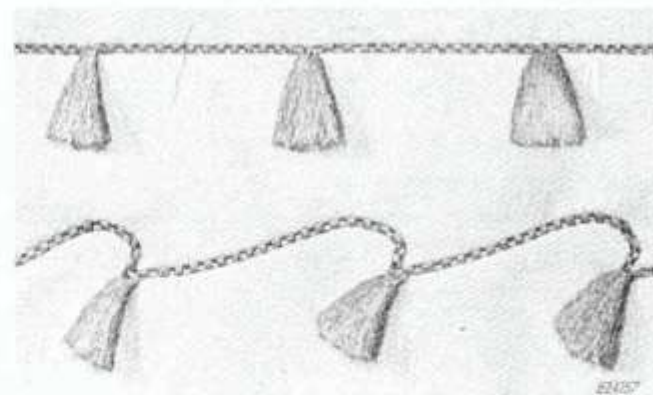

Fig. 180. Novelty Braiding with Straw Yarn

APPLIQUE



Fig. 181

Applique is effective on many types of apparel and fabric furnishings. Fabrics of like textures, as well as fabrics of different textures and weaves, are often used in appliqueing. For example, in lingerie, lustrous satin is appliquéd

to dull crepe to create beauty and interest by contrast in texture. Print fabrics are sometimes applied to plain fabrics in dresses, children's clothes, play clothes or linens, for accent. In draperies, motif and border prints may be applied to plain fabric of similar texture. When large motif designs are used in applique, the lines or sections of the design are frequently accented by continuing the stitching around these sections to bring out the design. In fabric furnishings such design sections are frequently padded to further accent the design and to give it a dimensional quality. Shadow applique on sheer fabrics is an important variation of plain applique and is described on **page 76**.

After stitching, portions of the design are cut away giving shadow contrast between portions of the design having double and single thickness.

Bold monograms of contrasting fabrics may be applied to bedspreads, blanket covers or other furnishings for the home.

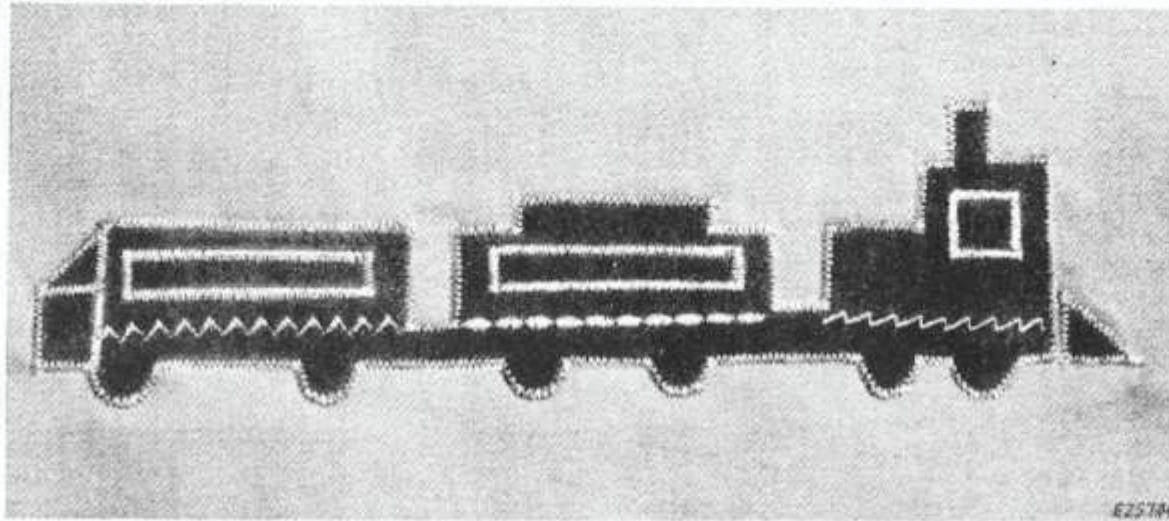

Fig. 182. Child's Appliqued Train Motif

A closely spaced satin stitch is usually used for applique making it unnecessary to turn raw edges to underside. The width of the satin stitch may be varied to accommodate the weave. Fine fabrics are appliqued with a narrow satin stitch, while coarse fabrics require a wide satin stitch. In many cases the design is stitched to the garment with a satin stitch and the edges are trimmed away later. An alternate procedure is often used where the design is stitched to the fabric with a short

straight stitch, the raw edges trimmed, and the satin stitch used to complete the outline, resulting in a smooth, lustrous edge. A trial sample is always made to determine the method most appropriate for the particular work being done, since applique is appropriate on such a diversity of fabrics.

Gay motifs from everyday life are spirited and smart for resort wear, play clothes or furnishings in children's rooms or recreation rooms.

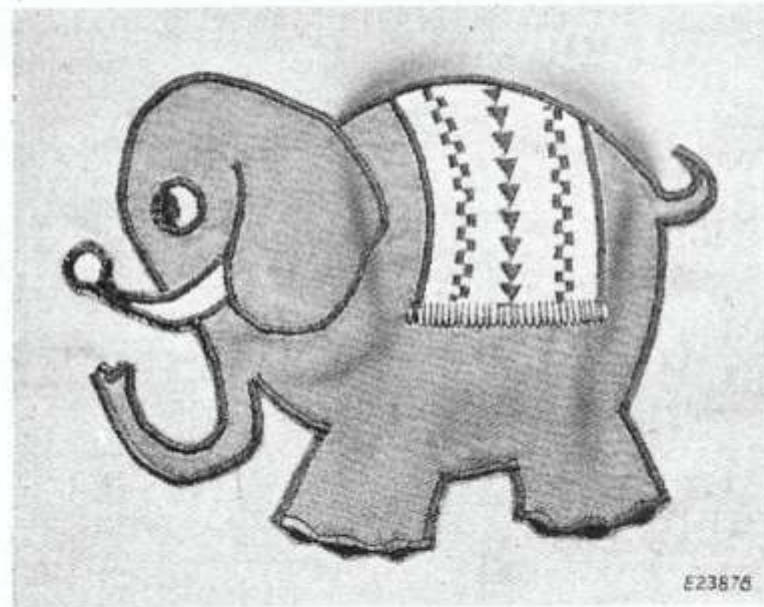

Fig. 183. Pocket Applique

The pocket applique, illustrated in **Fig. 183**, is made with a double thickness of fabric to provide a finish on the inside. All lines within the design are completed before the pocket is applied. Discs 3, 5 and 6 are used to give the stitched accents. The open portion of the pocket along the top edge is completed with a satin stitch before the motif is applied. The raw edge is trimmed along the stitching.

The design is then hand basted to the garment and the outline is stitched with a 12 to 25 straight stitch and trimmed. The final satin stitching on all outside edges is completed as a last step resulting in a durable and attractive applique. Such a pocket design is appropriate for children's wear. As a plain applique it is appropriate for furnishings in a child's room, for draperies, curtains, cushions, or bedspreads.

THE RUFFLER

Use: Straight Stitching Throat Plate
Ruffler 86642
Central Needle Position
0 Bight

PRINCIPAL PARTS OF RUFFLER

- A—Foot**—attaches ruffler to presser bar.
B—Fork Arm—straddles needle clamp.
C—Adjusting Screw—regulates fullness of gathers.
D—Projection—engages slots in adjusting lever.
E—Adjusting Lever—sets Ruffler for gathers or pleats.
F—Adjusting Finger—regulates depth or size of pleats.
G—Separator and Seam Guides—separates ruffle strip from fabric and facing—guides seam edges evenly.
H—Ruffling Blade—the upper, blue steel blade with teeth.
J—Separator Blade—lower blue blade keeps Ruffling Blade Teeth separate from Feed Dog Teeth.

TO OIL THE RUFFLER

The ruffler requires oiling at the beginning of

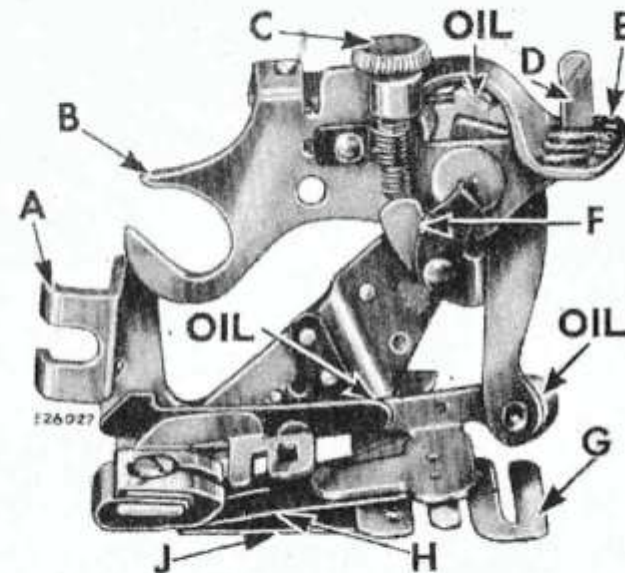

Fig. 184. Principal Parts of Ruffler

each working day to insure smooth operation and to prevent rust and wear.

Apply **one** drop of oil at each point indicated in **Fig. 184**, then wipe off excess oil. Operate ruffler with a piece of waste material until there is no oil on parts that come into contact with the work.

To Attach the Ruffler, raise needle to its highest point, loosen presser foot thumb screw and attach ruffler in place of presser foot, at same time placing fork arm **B** astride needle clamp. See that needle enters centre of needle hole in ruffler.

To Adjust Ruffler for Gathering, swing adjusting finger **F** away from needle. Raise adjusting lever **E** and move it until projection **D** can be entered in slot marked "1". Insert material to be ruffled between two blue blades and under separator guide. Draw material slightly back of needle, lower presser bar and sew. For fine gathering, turn adjusting screw **C** upward to shorten stroke. Set machine for a short stitch. For full gathering, turn adjusting screw **C** downward to lengthen stroke. Set the machine for a longer stitch.

To Make a Ruffle and Sew It to a Garment in One Operation, insert material to be ruffled between two blue blades and under separator guide. Place material to which ruffle is to be attached under separator blade and under separator guide. Proceed the same as for plain gathering.

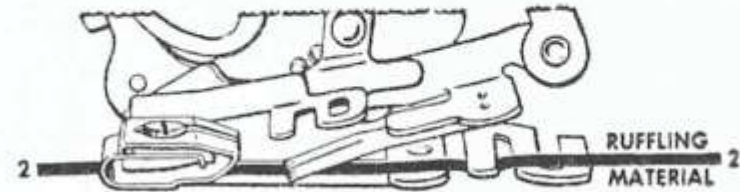

Fig. 185. Correct Position for Material to be Ruffled

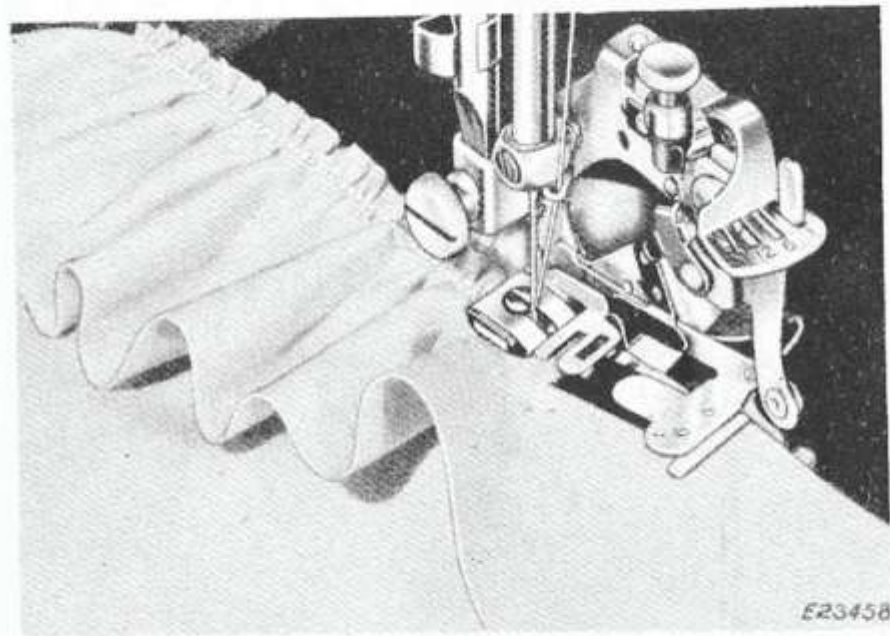

Fig. 186. Making a Ruffle and Attaching It in One Operation

To Adjust Ruffler for Pleating, raise adjusting lever **E** and move it until projection **D** can be entered in slot marked "6". The ruffler will then pleat once every 6 stitches. To pleat once every 12 stitches, have projection **D** enter slot "12" in adjusting lever **E**. Insert material to be pleated between two blue blades and under the separator guide.

To increase width of pleat, move adjusting finger **F** back toward needle and turn adjusting screw **C** downward. To make a smaller pleat, turn adjusting screw **C** upward. The distance between pleats is regulated by length of stitch.

To make the space between the groups of pleats, raise adjusting lever **E** and move it until projection **D** can be entered in small slot indicated by star on adjusting lever **E**. The ruffler will then stop pleating and plain stitching will be made.

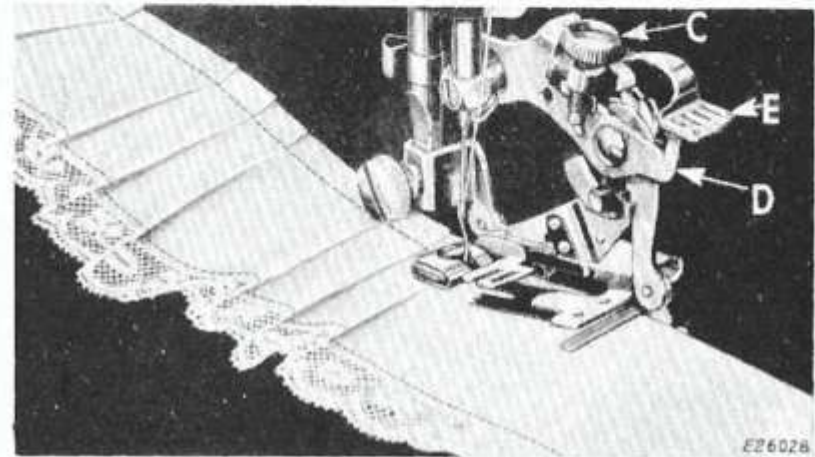

Fig. 187. Group Pleating with Ruffler

When desired space is made, set projection **D** in either of slots "6" or "12". Insert material to be pleated between two blue blades and under separator guide.

FAMILY MAINTENANCE SEWING

MENDING A RENT OR TEAR

Household linens, sheets, towels and pillow cases are quickly mended on the SINGER Automatic Swing-Needle Machine by holding an underlay of straight or bias fabric underneath the tear and stitching with the multiple stitch zigzag over the tear bringing the edges of the tear together and reinforcing them. The ends or corners are given added strength by using a shorter stitch length.

Use: All-purpose Throat Plate and Presser Foot
 Central Needle Position
 5 Bight
 25 to almost 0 Stitch
 Multiple Stitch Zigzag Lever B

MENDING TROUSER POCKET

Regulate machine in the same way as for mending a tear, and stitch pocket together allowing the needle to stitch very close to the edge on its right stroke, reinforcing the edge and closing the seam at the same time.

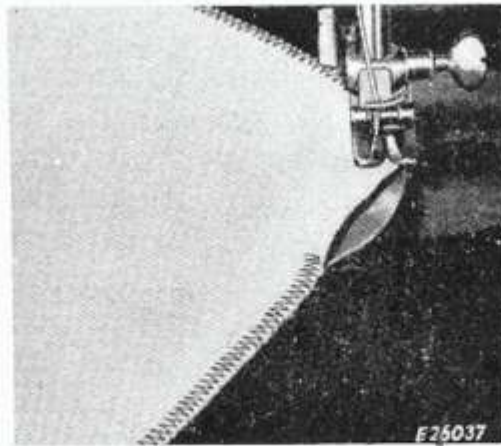

Fig. 189. Mending a Trouser Pocket

GIRDLE REPAIRS

Zigzag stitching is well suited for use on garments of an elastic nature that require firm, flexible stitching. The multiple stitch zigzag, as well as the plain zigzag, is appropriate for such repairs. The stitch length and bight are regulated according to the need. A needle slightly larger in size than is used for regular stitching is sometimes necessary to accommodate the multiple layers of fabric and elastic. Where both lengthwise and crosswise elasticity is important, multiple stitch zigzagging is best suited.

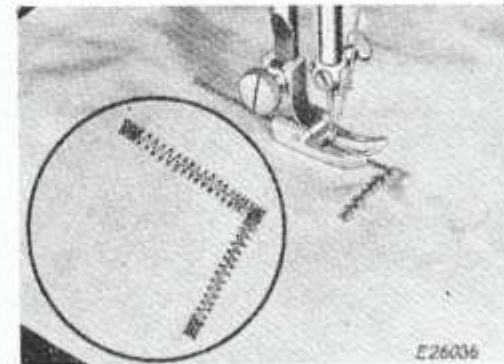

Fig. 188. Mending a Tear

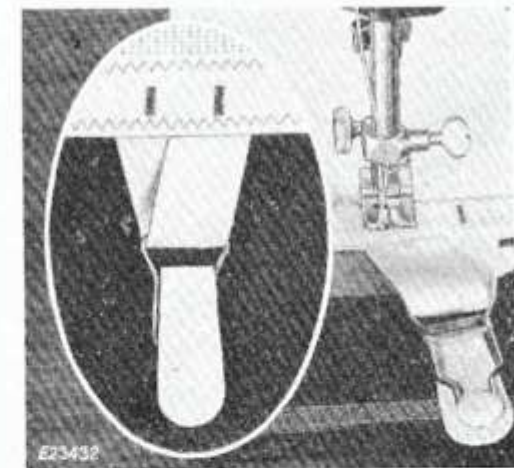

Fig. 190. Repairing a Girdle

ELASTIC WAISTBANDS

Use: All-purpose Throat Plate and
Presser Foot
Central Needle Position
2 Bight
12 Stitch
Lever A

Stretch elastic while stitching to provide the degree of fullness required in the garment. If a waistband, fit elastic for snugness on the individual and join ends of elastic. Divide both elastic and garment into quarters and pin at these intervals. Stretch elastic between these points to dimension of garment while stitching. With top edge of elastic in line with raw edge of garment, zigzag two rows, following the cords in the elastic. Trim away raw edge of garment near top line of stitching.

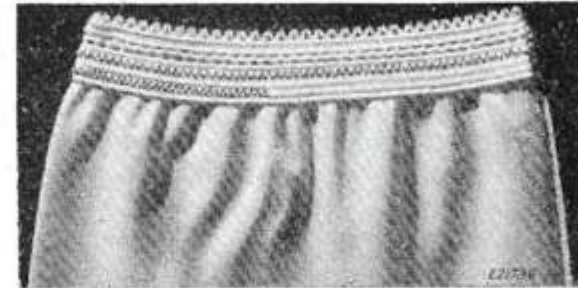

Fig. 191. Renewed Elastic Waistband

REPLACING BLANKET BINDING

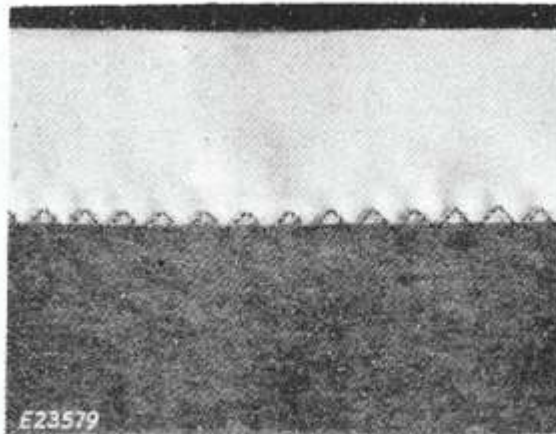

Fig. 192. Blanket Binding Replaced

The multiple stitch zigzag is an excellent stitch for applying blanket bindings and affords both a decorative and durable finish. Remove worn binding. Baste new binding securely in place. Stitch, using the All-purpose Throat Plate and Presser Foot, **5 bight, 12 to 25 stitch** and Multiple Stitch Zigzag Lever B. Increase pressure adjustment to accommodate the thickness of the blanket.

FASHION AIDS

DARNING

Stockings, children's balbriggans, leggings, and knit wear of all kinds as well as household linens are often darned on the sewing machine. The area near the worn section must be held taut in embroidery hoops. The feed is lowered and the presser foot removed. Refer to **page 70**, for lowering feed. Set **needle position** at **central** and **bight** at **0**, locking bight with screw **U**, **Fig. 51**, **page 31**.

When darning knitwear, reinforce opening by positioning needle $\frac{1}{4}$ " outside of hole, lower the presser bar to engage tension discs, and run reinforcing stitches $\frac{1}{4}$ " from edge completely around hole, moving hoops with both hands. This reinforcement may be omitted for firm fabrics whenever it seems to be desirable.

With a steady, continuous movement, move hoops backward and forward across hole, keeping the lines of stitching closely spaced and even in length. Slow movement of hoops will produce a short stitch while rapid move-

ment will produce a long stitch. For knit and tricot fabrics a longer stitch is best, because it is softer when the garment is worn. A short stitch is best for cottons and household linens, because it approximates the weave of the fabric and is strong enough to withstand many launderings.

Use: Lowered Feed (see **page 70**)
 Straight Stitching Throat Plate 105268
 Central Needle Position.
 0 Bight
 0 Stitch

Note: FASHION Aids are available for separate purchase at your local SINGER SEWING CENTRE.

SEAM GUIDE

The Seam Guide is helpful when stitching seams an exact width, and for stitching a uniform distance from a finished edge. Especially helpful for those just learning to sew and an aid to those demanding greater uniformity in seam width than the eye might give, the Seam Guide is a useful addition to your sewing equipment.

The scoring on the throat plate of your Swing Needle SINGER makes it easy for you to set the Seam Guide to an exact distance from the needle.

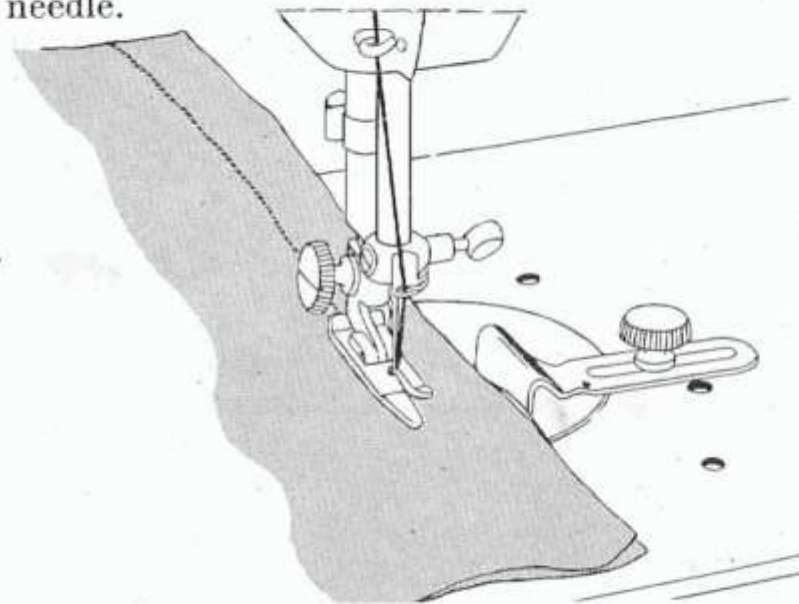

Fig. 193. Seam Guide on 319 Machine

TUCKER

The Tucker is a time-saver for making tucks up to one inch in width. Two adjustable scales are provided, the smaller near the needle is numbered from 1 to 8, expressing in eighths of an inch the width of the tuck. The larger scale expresses in quarter inches the spacing between tucks.

Set the tuck scale first for the width of tuck. The space scale is then adjusted using the needle as an indicator for the spacing between tucks. When both scales are set at the same number, blind tucks result. That is, the fold of one tuck just touches the stitching line of the next. When additional space between tucks is desired, adjust the space scale to a point beyond the tuck scale reading equal to the spacing desired, expressed in quarters of an inch. Thus half-inch tucks spaced a half inch apart require a tuck scale setting of 4, and a space scale setting of 6.

The Tucker must always be used with 0 bight setting and central needle position.

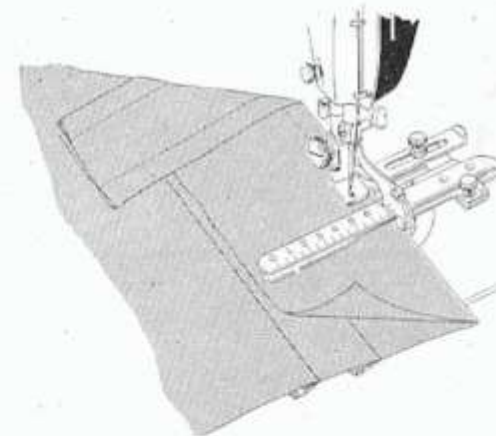

Fig. 194. Tucker in operation on 319 Machine

QUILTER

The Quilter, designed with a short, open foot and an adjustable and removable space guide, is especially well adapted to stitching lightly padded materials. The light padding is basted to the underside of the fabric and may be of outing flannel, canton flannel, sheet wadding or light wool interlining.

Replace the presser foot with the Quilter. Adjust the space guide for the width between stitching lines. Stitch with the padding next to the foot using a medium length stitch. Regulate the pressure slightly heavier than for medium weight fabrics.

The space guide may be used to the right or left of the needle. Straight stitching or zigzag or pattern stitching (maximum bight of 2) may be used.

In general, work from the centre to the edges. Guide fabric with both hands placed on the fabric so that the lengthwise grain forms a straight line between the hands.

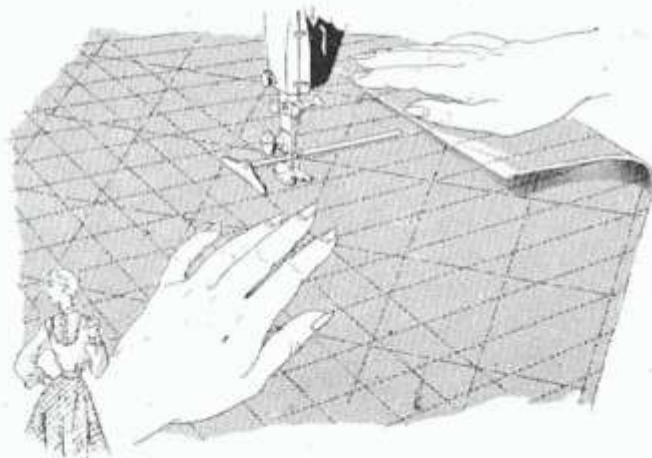

Fig. 195. Quilter in operation on 319 Machine

BIAS GAUGE

The Bias Gauge is very useful (especially in the case of soft materials) when cutting bias strips from $\frac{7}{16}$ inch to $1\frac{3}{8}$ inches in width. This is done by placing the

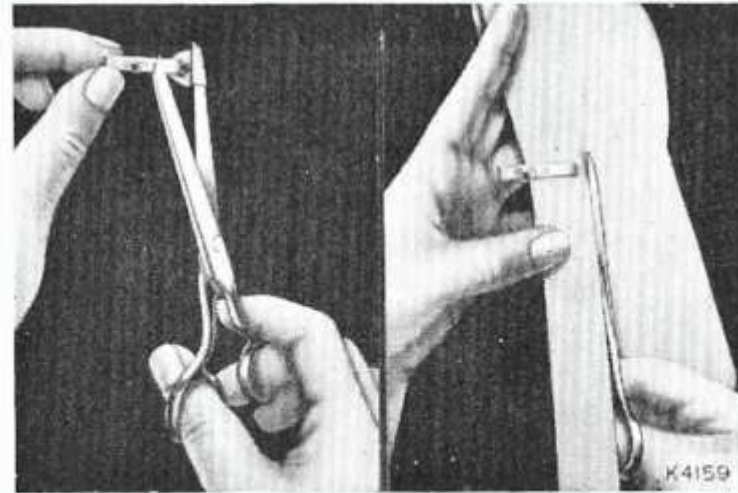

Fig. 196

bias gauge upon the point of the scissors and setting the blued indicator to the width desired. The line **F** is the point at which to set the blued indicator for facings, the line **B** for binding, and the line **C** for cording or piping.

Insert the material in the gauge with the edge against the blued indicator, and hold as shown in Fig. 196.

Bias binding should be cut $\frac{1}{2}$ inch wide, and to do this the indicator should be set midway between the lines **F** and **B**.

INDEX

| | PAGE | | PAGE |
|---|---------------|---|---------|
| Accented darts..... | 58 | Controller, speed | 5 |
| All-purpose stitching equipment..... | 52 | Corded edges with fabric covered cord..... | 82 |
| Applique..... | 76, 77, 94-96 | Cording scallops | 80 |
| Applique shadow hem..... | 76 | Cording seams..... | 62 |
| Appliqued lace..... | 77 | Couched elastic shirring | 60 |
| Appliqued pocket..... | 96 | | |
| Automatic stitching..... | 6-15 | Darning..... | 102 |
| Automatic stitching designs | 7-15 | Darts | 57 & 58 |
| | | Decorative stitching with twin needles | 14 & 15 |
| Bias gauge | 104 | Designs and motifs | 87 & 88 |
| Bight control | 30-32 | Drawing up bobbin thread | 25 |
| Binding blankets | 101 | | |
| Blind stitched and decorative hems..... | 72-76 | Edges | |
| Bobbin case, threading and replacing..... | 22 | Corded edges | 82 |
| Bobbin, removing | 19 | Fringed edges..... | 81 |
| Bobbin thread, drawing up..... | 25 | Scalloped edges | 83 |
| Bobbin thread tension, regulating..... | 38 & 39 | Elastic shirring, couched..... | 60 |
| Bobbin, winding..... | 20 & 21 | Elastic waistbands | 101 |
| Border designs..... | 89 & 90 | Electrical information | 5 |
| Braiding..... | 93 | Embroidered lace or Vienna work..... | 77 |
| Buttonhole pockets | 91 & 92 | | |
| Buttonholes, making | 67-69 | Fabric, thread, needle and stitch length chart..... | 16 |
| Buttons, sewing on..... | 70 | FASHION Aids..... | 102-104 |
| | | Bias gauge..... | 104 |
| Central needle position | 32 | Darners..... | 102 |
| Changing FASHION Discs..... | 33 | Quilter | 104 |
| Changing the throat plate | 42 | Seam guide | 103 |
| Circular hems..... | 75 | Tucker..... | 103 |
| Combination stitches | 9-13 & 15 | FASHION Discs, changing..... | 33 |
| Contour darts in interfacings | 57 | Features of 319K Machine | 4 |
| Contour shirring..... | 59 | Feed dog, lowering..... | 70 |
| Control of fullness | 59 | Feed, reversing direction..... | 28 |

| | PAGE | | PAGE |
|--|---------|--|---------|
| Fitted darts | 57 | Motifs and designs | 87 & 88 |
| Fringed edges | 81 | Motor | 5 |
| Gathered or puckered stitching | 46 | Names of parts | 54 |
| Gathering with ruffler | 98 | Needle breakage | 46 |
| Gimp, braiding with | 93 | Needle, fabric, thread and stitch length chart | 16 |
| Gimp, buttonholes | 69 | Needle position control | 32 |
| Girdle repairs | 100 | Needle, setting in needle clamp | 17 & 43 |
| Guiding and supporting material | 27 | Needle thread tension | 36 & 37 |
| Hairline seam in sheers | 62 | Needle threading | 18 & 44 |
| Heavy duty reversible seam | 63 | Needles and thread | 17 |
| Hems | | Novelty braiding | 93 |
| Applique shadow hems | 76 | Oiling the machine | 47-50 |
| Blended circular hems | 75 | Open seams, overcasting | 65 |
| Blind Stitched and decorative hems | 72-76 | Overedging seams | 66 |
| Blind Stitched, finished with seam tape | 74 | Overlapped seam for interlining | 64 |
| Shadow hems for tricot | 73 | Plain sewing | 56 |
| Shell Stitched hems | 78 | Pleating with ruffler | 99 |
| Hemstitching | 81 | Pocket applique | 96 |
| Hooks and eyes and snaps, sewing on | 71 | Pockets, buttonhole | 91 & 92 |
| Interfacing, contour dart | 57 | Preparing to sew | 23-25 |
| Invisible seam for all-over lace | 61 | Pressure on presser foot, regulating | 34 & 35 |
| Invisible seam for horsehair or net bandings | 63 | Quilter | 104 |
| Lace, invisible seams | 61 | Raised buttonholes | 69 |
| Left needle position | 32 | Removing the work | 26 |
| Length of stitch, regulating | 28 & 29 | Repairing a girdle | 100 |
| Light | 51 | Right needle position | 32 |
| Looped stitches | 46 | Rip-proof seam for lingerie | 62 |
| Mending a tear or rent | 100 | Ruffler and its uses | 97-99 |
| Mending trouser pocket | 100 | Rust damage protection | 47 |
| Monograms | 85 & 86 | | |

| | PAGE |
|---|-------------|
| Satin stitching..... | 28, 29 & 40 |
| Scalloped edges | 83 |
| Scalloped tucks..... | 84 |
| Scalloping | 83 & 84 |
| Scalloping, shadow, with twin needles..... | 84 |
| Scallops, satin stitched and corded | 79 & 80 |
| Script stitch | 86 |
| Seam finishes | 65 & 66 |
| Seam guide | 103 |
| Seaming dress sections | 56 |
| Seams | |
| Cording seams | 62 |
| Hairline seams | 62 |
| Heavy duty reversible seams | 63 |
| Invisible seams | 61 & 63 |
| Overcast open seams | 65 |
| Overedged seams | 66 |
| Overlapped seams | 64 |
| Plain seams..... | 56 |
| Rip-proof seams | 62 |
| Stayed seams..... | 64 |
| Zigzag seams..... | 61 |
| Setting the needle | 17 & 43 |
| Sewing suggestions..... | 46 |
| Shadow hem for tricot..... | 73 |
| Shell stitched hems | 78 |
| Shirring | 59 & 60 |
| SINGER service..... | 3 |
| Skipped stitches | 46 |
| Snaps and hooks and eyes, sewing on..... | 71 |
| Speed controller | 5 |
| Starting at a given place in a design | 29 |
| Starting to sew | 26 |

| | PAGE |
|--|---------|
| Stayed seam for jersey or crepe | 64 |
| Stitch length, fabric, thread and needle chart | 16 |
| Stitch length, regulating | 28 & 29 |
| Stitch levers | 6 |
| Straight stitching | 55 & 56 |
| Straight stitching equipment | 53 |
| Tension assembly, removing and replacing ... | 41 & 42 |
| Tensions, regulating..... | 36-40 |
| Thread and needles | 17 |
| Thread breakage..... | 46 |
| Thread, fabric, needle and stitch length chart..... | 16 |
| Thread tensions for straight stitching | 36-40 |
| Threading bobbin case | 22 |
| Threading the needle..... | 18 & 44 |
| Throat plate changing | 42 |
| Torso or shaped darts | 57 |
| Tucker..... | 103 |
| Tucks, scalloped | 84 |
| Twin needle decorative stitching | 14 & 15 |
| Twin needles, setting..... | 43 |
| Twin needle stitching | 45 |
| Twin needles, threading | 44 |
| Upper threading..... | 18 & 44 |
| Vienna work or embroidered lace | 77 |
| Voltage for electric motor operation | 5 |
| Winding the bobbin | 20 & 21 |
| Zigzag seaming | 61 |

SINGER

NEEDLE THREADER

No. 189693

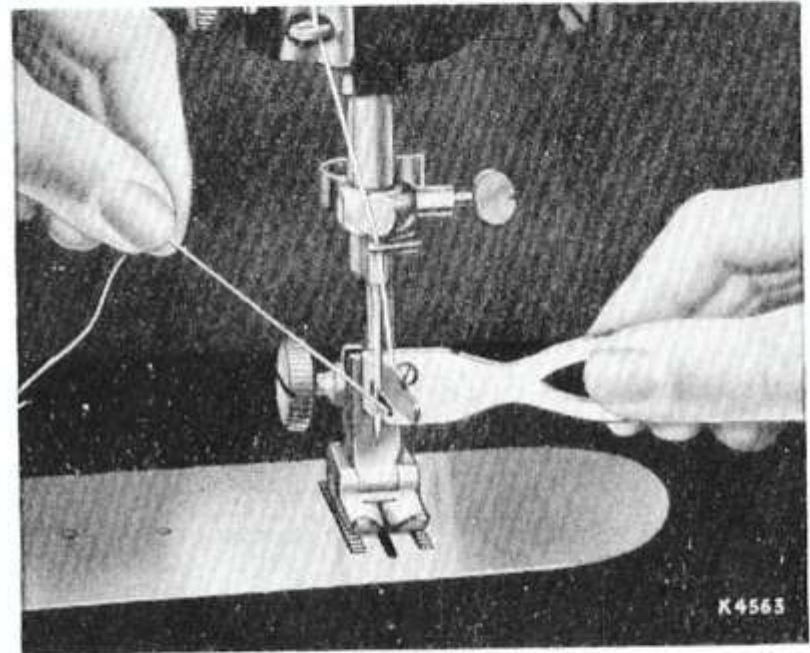

FOR USE ON MACHINES WHERE THE NEEDLE IS THREADED
FROM FRONT TO BACK

TO ALL WHOM IT MAY CONCERN:

The improper placing or renewal of the Trade Mark **SINGER** or any other of the Trade Marks of The Singer Manufacturing Company (all of which are duly Registered Trade Marks) on any machine that has been repaired, rebuilt, reconditioned, or altered in any way whatsoever outside a **SINGER** factory or an authorised **SINGER** agency is forbidden.

Printed in Great Britain

FOR YOUR PROTECTION

SINGER Sewing Machines are sold and serviced wherever you see the famous SINGER and Red "S" Trademarks. When your machine needs servicing call your SINGER SEWING CENTRE to be sure of warranted SINGER parts and service. See address in the classified telephone directory.

SINGER SEWING MACHINE COMPANY

